

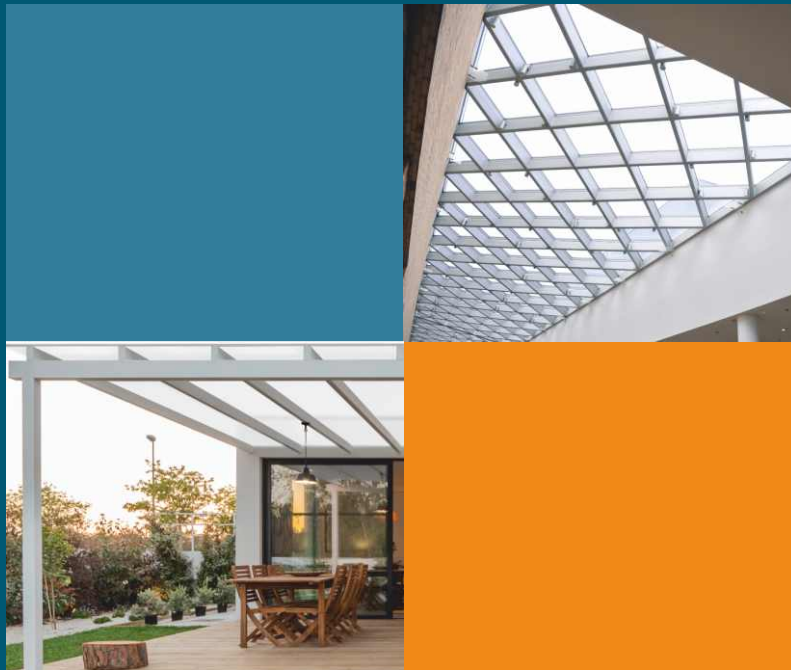

Robelit®

-  ZADASZENIA
-  CANOPIES
-  VORDÄCHER
-  AUVENTS



architectural plastics solutions



Robelit Sp. z o.o.
ul. Legionów 79
42-200 Częstochowa
tel. +48 34 377 42 98
e-mail: info@robelit.pl
www.robelit.pl

O firmie



Marka Robelit powstała na bazie firmy Billdecor, której właścicielem był Ireneusz Bill. Spółkę zawiązano w oparciu o kapitał polski i zagraniczny. W pierwszych latach działalności firma dostarczała wszelkiego rodzaju materiały z tworzyw sztucznych dystrybuując produkty budowlane i wykończeniowe wiodących światowych producentów.

Spółka jako pierwszy podmiot w Polsce uzyskała aprobatę techniczną ITB na płyty komorowe z poliwęglanu, a następnie na płyty akrylowe. Firma mocno wsłuchiwała się w potrzeby klientów, dlatego szybko zaczęła dostarczać materiały na przejrzyste ekrany akustyczne. W związku ze zmianą polityki sprzedaży obsługa tego rynku została przekazana spółce Calvero.

Historia współpracy z partnerami sięga nawet kilkudziesięciu lat. Dobre stosunki z dostawcami i odbiorcami opierają się na wzajemnym zaufaniu i lojalności. Zasady współpracy dopełniają umowy handlowe. Komfort działania i bezpieczeństwo naszych klientów wpływa z troski firmy o wysoką jakość produktów i serwisu.

Znaczące rozszerzenie oferowanych produktów w 2016 roku znalazło swoje odzwierciedlenie również w liftingu wizerunkowym marki. Redesign znaku graficznego odświeżył komunikację wizualną i zwiększył potencjał marki.

Wizją firmy Robelit jest bycie wiarygodnym i odpowiedzialnym partnerem biznesowym postrzeganym jako lojalny dostawca szerokiej gamy produktów, a także wiodący dystrybutor materiałów wykończeniowych z tworzyw sztucznych dla budownictwa.

W 2021 roku spółka kupiła firmę Calvero - producenta daszków i zadaszeń. Decyzja zakupu wpisana się w wizję firmy, aby zwiększyć dynamizm jej działań i lepiej odpowiadać na wzrastające wymagania klientów. Ufamy, że krok ten umocni naszą pozycję na rynku i przyczyni się do wzrostu wartości firmy.



10.000.000
m² sprzedanego
poliwęglanu



29
lat doświadczenia



200.000
zadowolonych
klientów

Robbelit[®]



Robbelit



Robbelit

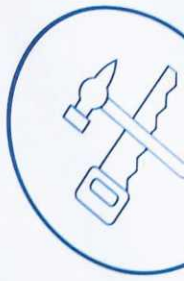



Indeks 170900 - str 8



Indeks
M0843
str 64



Indeks
M0309
str 72























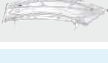

Indeks
170762
str 62

Indeks
170760
str 60

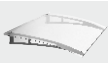

Indeks
170900
str 8

LIGHTLINE

| | | |
|---|---|-----------|
|  | LIGHTLINE L1500 | 8 |
|  | LIGHTLINE L1900 | 10 |
|  | LIGHTLINE L2700 | 12 |
|  | LIGHTLINE XL2050 | 14 |
|  | LIGHTLINE Moduł bazowy L | 16 |
|  | LIGHTLINE Moduł rozszerzeniowy L | 18 |
|  | LIGHTLINE Moduł bazowy XL | 20 |
|  | LIGHTLINE Moduł rozszerzeniowy XL | 24 |
|  | LIGHTLINE Daszek dwuspadowy GL1500 | 26 |
|  | LIGHTLINE Daszek łukowy RL1500 | 28 |
|  | LIGHTLINE Daszek łukowy RL1900 | 30 |
|  | LIGHTLINE Daszek łukowy RL2500 | 32 |
|  | LIGHTLINE Ścianka L | 34 |
|  | LIGHTLINE Ścianka XL | 36 |
|  | PICOTOP | 38 |
|  | EASYTOP | 40 |
|  | EXCLUSIVELINE | 42 |
|  | FLIPTOP | 44 |
|  | EUROTOP | 46 |
|  | EXTRA | 48 |
|  | SMART | 50 |
|  | DASZEK SZKLANY | 52 |
|  | LIGHTLINE L1500 | 54 |



**Możliwość montażu
ścianki bocznej**



**Możliwość montażu
dwóch ścianek bocznych**









MODERN

| | | |
|---|-----------------------------|----|
|  | Daszek łukowy | 56 |
|  | Ścianka do daszka łukowego | 58 |
|  | Daszek płaski | 60 |
|  | Ścianka do daszka płaskiego | 62 |
|  | Daszek łukowy „EKO” | 64 |
|  | Daszek łukowy z akrylu | 66 |
|  | Daszek płaski z akrylu | 68 |
|  | Daszek balkonowy | 70 |
|  | Daszek jednostronnie łukowy | 72 |
|  | Daszek płaski PLUS | 74 |
|  | Daszek ARCO PLUS | 76 |

CLASSICA

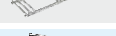





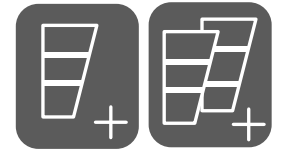
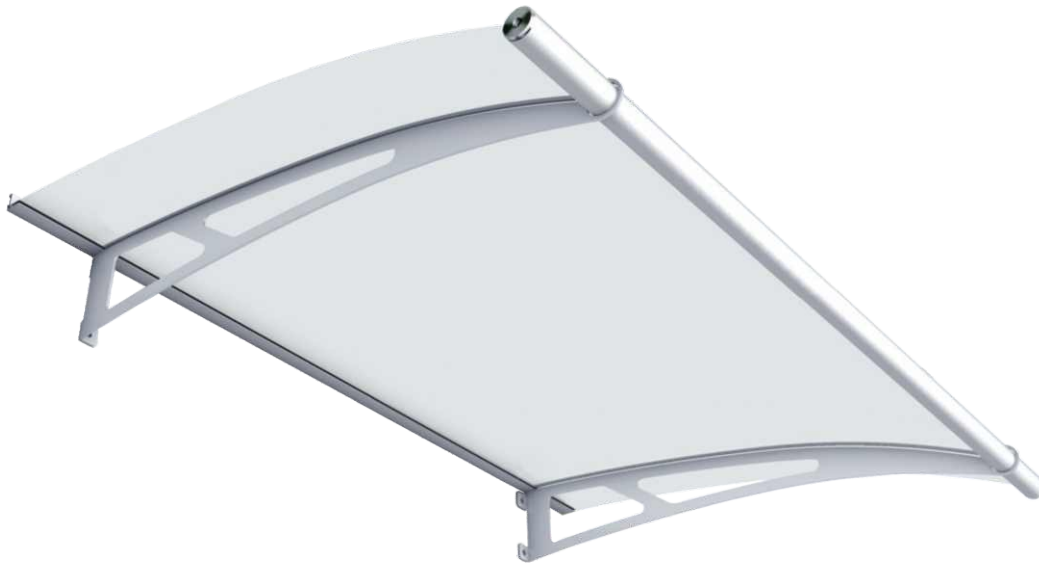

| | | |
|---|-----------------------------------|----|
|  | Daszek ARCO | 76 |
|  | Daszek ARCO Retro | 78 |
|  | Daszek łukowy Retro | 80 |
|  | Ścianka do daszka łukowego Retro | 82 |
|  | Daszek płaski Retro | 84 |
|  | Ścianka do daszka płaskiego Retro | 86 |

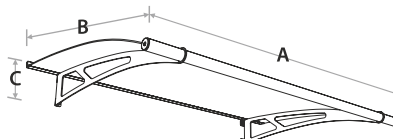
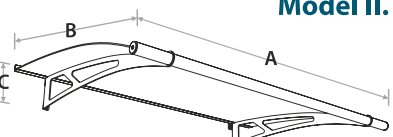
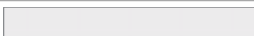
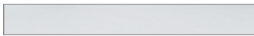
AKCESORIA

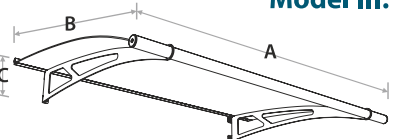
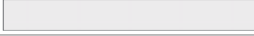
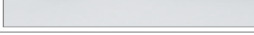
| | | |
|---|----------------------------|----|
|  | Wiata rowerowa LASTRA | 88 |
|  | Ścianka do wiaty rowerowej | 88 |
|  | Stojak rowerowy S | 88 |
|  | Stojak rowerowy L | 88 |
|  | Wiata rowerowa | 92 |
|  | Ścianka do wiaty rowerowej | 92 |
|  | Lampion | 96 |
|  | Popielnica | 97 |

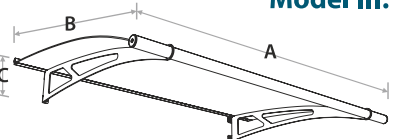
LIGHTLINE L1500

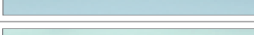

|  Model I. | Model | | | Wypełnienie | Indeks | Lp. |
|---|--------|--------|--------|--|--------|-----|
| | A (cm) | B (cm) | C (cm) | | | |
|  Model II. | 150 | 95 | 17 |  | 160900 | 1 |
| | | | |  | 160901 | 2 |
| | | | |  | 160902 | 3 |
| | | | |  | 160903 | 4 |
|  Model III. | 150 | 95 | 17 |  | 170900 | 5 |
| | | | |  | 170901 | 6 |
| | | | |  | 170902 | 7 |
| | | | |  | 170903 | 8 |
|  Model III. | 150 | 95 | 17 |  | 180900 | 9 |
| | | | |  | 180901 | 10 |
| | | | |  | 180902 | 11 |
| | | | |  | 180903 | 12 |

 **Wypełnienie daszków** - płyta akrylowa 4 mm.

przejrzysty

satyna biała

satyna niebieska

satyna zielona

Konstrukcja daszków:

| | | |
|---|---|--|
| Model I. Nogi podporowe – stal czarna ocynkowana lakierowana proszkowo RAL9010 Rynna, profil przyścienny – aluminium | Model II. Nogi podporowe – stal nierdzewna (V2A) Rynna, profil przyścienny – aluminium anodowane | Model III. Nogi podporowe – stal kwasoodporna (V4A) Rynna, profil przyścienny – aluminium anodowane |
|---|---|--|

Waga daszków - 18 kg / sztuka

Wymiar opakowania – 152x95x8cm

Paletowanie – 30 sztuk/paleta

Wymiar palety – 154x97x260 cm

– Waga palety+30 daszków 560 kg brutto



LIGHTLINE L1500

Acrylic plate 4 mm.

transparent

satin white

satin blue

satin green

Construction of conopies:

| | | |
|--|--|--|
| <p>Model I. Supporting legs – galvanized steel black powder coated RAL9010 Gutter, wall profile – galvanized aluminum powder coated RAL9010</p> | <p>Model II. Supporting legs – stainless steel (V2A) Gutter, wall profile – anodized aluminum</p> | <p>Model III. Supporting legs – acid resistant steel (V4A) Gutter, wall profile – anodized aluminum</p> |
|--|--|--|

Weight of conopies - 18 kg / pcs.

Size of packaging – 152x95x8 cm

Palletizing – 30 pcs./palette

Size of palette – 154x97x260 cm
– Weight of palette +30 conopies 560 kg brutto

Complete set for self assembly.



LIGHTLINE L1500

Füllung – Acrylglas 4mm.

klar

satiniert weiß

satiniert blau

satiniert gruen

Konstruktion:

| | | |
|---|---|---|
| <p>Modell I: Träger – Stahl Schwarz verzinkt, pulverbeschichtet RAL9010 Regenrinne, Wandprofil - Aluminium pulverbeschichtet RAL9010</p> | <p>Modell II: Träger – Edelstahl (V2A) Regenrinne, Wandprofil - aus eloxiertem Aluminium</p> | <p>Modell III: Träger – Stahl mit suäre Widerstandsfähigkeit (V4A) Regenrinne, Wandprofil - aus eloxiertem Aluminium</p> |
|---|---|---|

Gewicht - 18 kg

Abmessungen der Verpackung – 152x95x8cm

Paletteneinheit 30 Stück

Abmessungen der Palette – 154x97x260cm
Gewicht der Palette 560 kg brutto

Komplett mit Schrauben und Dübel zur Selbstmontage.



LIGHTLINE L1500

Réalisation des auvents – plaque acrylique 4 mm.

Clair

Satiné Blanc

Satiné Bleu

Satiné Vert

Construction des auvents:

| | | |
|--|---|---|
| <p>Le modèle I. Supports – acier noir galvanisé, paint en pulvérisation RAL 9010 Goutière, profilé du près du mur – aluminium paint en pulvérisation RAL 9010</p> | <p>Le modèle II. Supports en acier inoxydable (V2A) Goutière, profilé du près du mur – aluminium anodisé</p> | <p>Le modèle III. Supports - Acier resistant aux acides (V4A) Goutière, profilé du près du mur – aluminium anodisé</p> |
|--|---|---|

Poids -18 kg/pièce

Dimensions du colis - 152x95x8 cm

Palletisation - 30 pièces / palette

Dimension de la palette - 154x97x260 cm
Poids de la palette + 30 auvents 560 kg brut

Inclus les vis et les chevilles pour le montage individuel.

LIGHTLINE L1900



| Model I. | Model | | | Wypełnienie | Indeks | Lp. |
|-----------------------|--------|--------|--------|-------------|--------|-----|
| | A (cm) | B (cm) | C (cm) | | | |
| Model II. | 190 | 95 | 17 | | 160910 | 13 |
| | | | | | 160911 | 14 |
| | | | | | 160912 | 15 |
| | | | | | 160913 | 16 |
| Model III. | 190 | 95 | 17 | | 170910 | 17 |
| | | | | | 170911 | 18 |
| | | | | | 170912 | 19 |
| | | | | | 170913 | 20 |
| Model III. | 190 | 95 | 17 | | 180910 | 21 |
| | | | | | 180911 | 22 |
| | | | | | 180912 | 23 |
| | | | | | 180913 | 24 |

Wypełnienie daszków - płyta akrylowa 4 mm.

przejrzysty

satyna biała

satyna niebieska

satyna zielona

Konstrukcja daszków:

| | | |
|---|---|--|
| Model I. Nogi podporowe – stal czarna ocynkowana lakierowana proszkowo RAL9010 Rynna, profil przyścienny – aluminium | Model II. Nogi podporowe – stal nierdzewna (V2A) Rynna, profil przyścienny – aluminium anodowane | Model III. Nogi podporowe – stal kwasoodporna (V4A) Rynna, profil przyścienny – aluminium anodowane |
|---|---|--|

Waga daszków - 23 kg / sztuka

Wymiar opakowania – 197x91x8cm

Paletowanie – 30 sztuk/paleta

Wymiar palety – 199x93x180 cm

– Waga palety+30 daszków 720 kg brutto



LIGHTLINE L1900

Acrylic plate 4 mm.

transparent

satin white

satin blue

satin green

Construction of conopies:

| | | |
|---|---|---|
| Model I. Supporting legs – galvanized steel black powder coated RAL9010 Gutter, wall profile – galvanized aluminum powder coated RAL9010 | Model II. Supporting legs – stainless steel (V2A) Gutter, wall profile – anodized aluminum | Model III. Supporting legs – acid resistant steel (V4A) Gutter, wall profile – anodized aluminum |
|---|---|---|

Weight of conopies - 23 kg / pcs.

Size of packaging – 197x91x8 cm

Palletizing – 30 pcs./palette

Size of palette – 199x93x180 cm
– Weight of palette +30 conopies 720 kg brutto

Complete set for self assembly.



LIGHTLINE L1900

Füllung – Acrylglas 4mm.

klar

satiniert weiß

satiniert blau

satiniert grün

Konstruktion:

| | | |
|--|--|--|
| Modell I: Träger - Stahl Schwarz verzinkt, pulverbeschichtet RAL9010 Regenrinne, Wandprofil - Aluminium pulverbeschichtet RAL9010 | Modell II: Träger – Edelstahl (V2A) Regenrinne, Wandprofil - aus eloxiertem Aluminium | Modell III: Träger – Stahl mit saure Widerstandsfähigkeit (V4A) Regenrinne, Wandprofil - aus eloxiertem Aluminium |
|--|--|--|

Gewicht - 23 kg

Abmessungen der Verpackung – 197x91x8cm

Paletteneinheit 30 Stück

Abmessungen der Palette – 199x93x180cm
Gewicht der Palette 720 kg brutto

Komplett mit Schrauben und Dübel zur Selbstmontage.



LIGHTLINE L1900

Réalisation des auvents – plaque acrylique 4 mm.

Clair

Satiné Blanc

Satiné Bleu

Satiné Vert

Construction des auvents:

| | | |
|--|---|---|
| Le modèle I. Supports – acier noir galvanisé, peint en pulvérisation RAL 9010 Gouttière, profilé du près du mur – aluminium peint en pulvérisation RAL 9010 | Le modèle II. Supports en acier inoxydable (V2A) Gouttière, profilé du près du mur – aluminium anodisé | Le modèle III. Supports - Acier résistant aux acides (V4A) Gouttière, profilé du près du mur – aluminium anodisé |
|--|---|---|

Poids - 23 kg/pièce

Dimensions du colis - 197x91x8 cm

Palletisation - 30 pièces / palette

Dimension de la palette - 199x93x180 cm
Poids de la palette + 30 auvents 720 kg brut

Inclus les vis et les chevilles pour le montage individuel.

LIGHTLINE L2700



| Model I. | Model | | | Wypełnienie | Indeks | Lp. |
|-------------------|--------------|--------|--------|--------------------|---------------|------------|
| | A (cm) | B (cm) | C (cm) | | | |
| Model II. | 270 | 95 | 17 | | 160920 | 25 |
| | | | | | 160921 | 26 |
| | | | | | 160922 | 27 |
| | | | | | 160923 | 28 |
| Model III. | 270 | 95 | 17 | | 170920 | 29 |
| | | | | | 170921 | 30 |
| | | | | | 170922 | 31 |
| | | | | | 170923 | 32 |
| Model III. | 270 | 95 | 17 | | 180920 | 33 |
| | | | | | 180921 | 34 |
| | | | | | 180922 | 35 |
| | | | | | 180923 | 36 |

Wypełnienie daszków - płyta akrylowa 4 mm.

przejrzysty

satyna biała

satyna niebieska

satyna zielona

Konstrukcja daszków:

| | | |
|---|---|--|
| Model I. Nogi podporowe – stal czarna ocynkowana lakierowana proszkowo RAL9010 Rynna, profil przyścienny – aluminium | Model II. Nogi podporowe – stal nierdzewna (V2A) Rynna, profil przyścienny – aluminium anodowane | Model III. Nogi podporowe – stal kwasoodporna (V4A) Rynna, profil przyścienny – aluminium anodowane |
|---|---|--|

Waga daszków - 29 kg / sztuka

Wymiar opakowania – 277x91x8cm

Paletowanie – 30 sztuk/paleta

Wymiar palety – 279x93x180 cm

– Waga palety+30 daszków 900 kg brutto

W komplecie śruby i kołki rozporowe do samodzielnego montażu daszka.



LIGHTLINE L2700

Acrylic plate 4 mm.

transparent

satin white

satin blue

satin green

Construction of conopies:

| | | |
|---|--|---|
| Model I. Supporting legs – galvanized steel black powder coated RAL9010 Gutter, wall profile – galvanized aluminum powder coated RAL9010 | Model II. Supporting legs – stainless steel (V2A) Gutter, wall profile – anodized aluminum | Model III. Supporting legs – acid resistant steel (V4A) Gutter, wall profile – anodized aluminum |
|---|--|---|

Weight of conopies - 29 kg / pcs.

Size of packaging – 277x91x8 cm

Palletizing – 30 pcs./palette

Size of palette – 279x93x180 cm
– Weight of palette +30 conopies 900 kg brutto

Complete set for self assembly.



LIGHTLINE L2700

Füllung – Acrylglas 4mm.

klar

satiniert weiß

satiniert blau

satiniert gruen

Konstruktion:

| | | |
|--|---|--|
| Modell I: Träger - Stahl Schwarz verzinkt, pulverbeschichtet RAL9010 Regenrinne, Wandprofil - Aluminium pulverbeschichtet RAL9010 | Modell II: Träger – Edelstahl (V2A) Regenrinne, Wandprofil - aus eloxiertem Aluminium | Modell III: Träger – Stahl mit suäre Widerstandsfähigkeit (V4A) Regenrinne, Wandprofil - aus eloxiertem Aluminium |
|--|---|--|

Gewicht - 29 kg

Abmessungen der Verpackung – 277x91x8cm

Paletteneinheit 30 Stück

Abmessungen der Palette – 279x93x180cm
Gewicht der Palette 900 kg brutto

Komplett mit Schrauben und Dübel zur Selbstmontage.



LIGHTLINE L2700

Réalisation des auvents – plaque acrylique 4 mm.

Clair

Satiné Blanc

Satiné Bleu

Satiné Vert

Construction des auvents:

| | | |
|---|--|---|
| Le modèle I. Supports – acier noir galvanisé, peint en pulvérisation RAL 9010 Gouttière, profilé du près du mur – aluminium peint en pulvérisation RAL 9010 | Le modèle II. Supports en acier inoxydable (V2A) Gouttière, profilé du près du mur – aluminium anodisé | Le modèle III. Supports - Acier résistant aux acides (V4A) Gouttière, profilé du près du mur – aluminium anodisé |
|---|--|---|

Poids - 29 kg/pièce

Dimensions du colis - 277x91x8 cm

Palletisation - 30 pièces / palette

Dimension de la palette - 279x93x180 cm
Poids de la palette + 30 auvents 900 kg brut

Inclus les vis et les chevilles pour le montage individuel.

LIGHTLINE XL



| Model I. | Model | | | Wypełnienie | Indeks | Lp. |
|-------------------|--------------|--------|--------|--------------------|---------------|------------|
| | A (cm) | B (cm) | C (cm) | | | |
| Model II. | 205 | 142 | 25 | | 160940 | 37 |
| | | | | | 160941 | 38 |
| | | | | | 160942 | 39 |
| | | | | | 160943 | 40 |
| Model III. | 205 | 142 | 25 | | 170940 | 41 |
| | | | | | 170941 | 42 |
| | | | | | 170942 | 43 |
| | | | | | 170943 | 44 |
| Model III. | 205 | 142 | 25 | | 180940 | 45 |
| | | | | | 180941 | 46 |
| | | | | | 180942 | 47 |
| | | | | | 180943 | 48 |

Wypełnienie daszków - płyta akrylowa 6 mm.

przejrzysty
 satyna biała
 satyna niebieska
 satyna zielona

Konstrukcja daszków:

| | | |
|---|---|--|
| Model I. Nogi podporowe – stal czarna ocynkowana lakierowana proszkowo RAL9010 Rynna, profil przyścienny – aluminium | Model II. Nogi podporowe – stal nierdzewna (V2A) Rynna, profil przyścienny – aluminium anodowane | Model III. Nogi podporowe – stal kwasoodporna (V4A) Rynna, profil przyścienny – aluminium anodowane |
|---|---|--|

Waga daszków - 42 kg / sztuka

Wymiar opakowania – 209x135x8cm

Paletowanie – 30 sztuk/paleta

Wymiar palety – 211x137x190 cm

– Waga palety+30 daszków 1300 kg brutto

W komplecie śruby i kołki rozporowe do samodzielnego montażu daszka.



LIGHTLINE XL

Acrylic plate 6 mm.

transparent

satin white

satin blue

satin green

Construction of conopies:

| | | |
|---|--|---|
| Model I. Supporting legs – galvanized steel black powder coated RAL9010 Gutter, wall profile – galvanized aluminum powder coated RAL9010 | Model II. Supporting legs – stainless steel (V2A) Gutter, wall profile – anodized aluminum | Model III. Supporting legs – acid resistant steel (V4A) Gutter, wall profile – anodized aluminum |
|---|--|---|

Weight of conopies - 42 kg / pcs.

Size of packaging – 209x135x8 cm

Palletizing – 30 pcs./palette

Size of palette – 211x137x190 cm
– Weight of palette +30 conopies 1300 kg brutto

Complete set for self assembly.



LIGHTLINE XL

Füllung – Acrylglas 6 mm.

klar

satiniert weiß

satiniert blau

satiniert gruen

Konstruktion:

| | | |
|--|---|--|
| Modell I: Träger - Stahl Schwarz verzinkt, pulverbeschichtet RAL9010 Regenrinne, Wandprofil - Aluminium pulverbeschichtet RAL9010 | Modell II: Träger – Edelstahl (V2A) Regenrinne, Wandprofil - aus eloxiertem Aluminium | Modell III: Träger – Stahl mit suäre Widerstandsfähigkeit (V4A) Regenrinne, Wandprofil - aus eloxiertem Aluminium |
|--|---|--|

Gewicht - 42 kg

Abmessungen der Verpackung – 209x135x8cm

Paletteneinheit 30 Stück

Abmessungen der Palette – 211x137x190cm
Gewicht der Palette 1300 kg brutto

Komplett mit Schrauben und Dübel zur Selbstmontage.



LIGHTLINE XL

Réalisation des auvents – plaque acrylique 6 mm.

Clair

Satiné Blanc

Satiné Bleu

Satiné Vert

Construction des auvents:

| | | |
|---|--|---|
| Le modèle I. Supports – acier noir galvanisé, paint en pulvérisation RAL 9010 Gouttière, profilé du près du mur – aluminium paint en pulvérisation RAL 9010 | Le modèle II. Supports en acier inoxydable (V2A) Gouttière, profilé du près du mur – aluminium anodisé | Le modèle III. Supports - Acier résistant aux acides (V4A) Gouttière, profilé du près du mur – aluminium anodisé |
|---|--|---|

Poids - 42 kg/pièce

Dimensions du colis - 209x135x8 cm

Palletisation - 30 pièces / palette









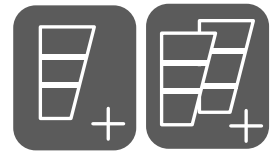

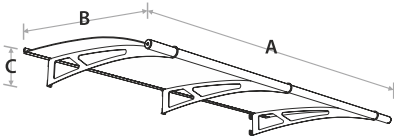
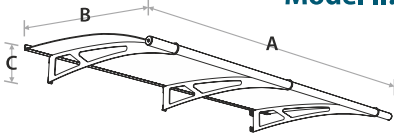
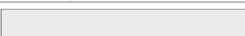
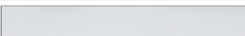
Dimension de la palette - 211x137x190 cm
Poids de la palette + 30 auvents 1300 kg brut

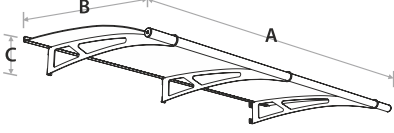
Inclus les vis et les chevilles pour le montage individuel.

LIGHTLINE SYSTEM MODUŁOWY „L”

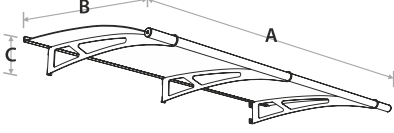
MODUŁ BAZOWY

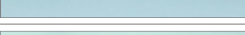

|  Model I. | Model | | | Wypełnienie | Indeks | Lp. |
|---|--------|--------|--------|--|--------|-----|
| | A (cm) | B (cm) | C (cm) | | | |
|  Model II. | 191,6 | 95 | 17 |  | 160540 | 49 |
| | | | |  | 160542 | 50 |
| | | | |  | 160544 | 51 |
| | | | |  | 160546 | 52 |
|  Model III. | 191,6 | 95 | 17 |  | 170540 | 53 |
| | | | |  | 170542 | 54 |
| | | | |  | 170544 | 55 |
| | | | |  | 170946 | 56 |
|  Model III. | 191,6 | 95 | 17 |  | 180440 | 57 |
| | | | |  | 180542 | 58 |
| | | | |  | 180544 | 59 |
| | | | |  | 180546 | 60 |

 **Wypełnienie daszków** - płyta akrylowa 4 mm.

przejrzysty

satyna biała

satyna niebieska

satyna zielona

Konstrukcja daszków:

| | | |
|---|---|--|
| Model I. Nogi podporowe – stal czarna ocynkowana lakierowana proszkowo RAL9010 Rynna, profil przyścienny – aluminium lakierowane proszkowo RAL9010 | Model II. Nogi podporowe – stal nierdzewna (V2A) Rynna, profil przyścienny – aluminium anodowane | Model III. Nogi podporowe – stal kwasoodporna (V4A) Rynna, profil przyścienny – aluminium anodowane |
|---|---|--|

Waga daszków - 20 kg / sztuka

Wymiar opakowania – 110x110x8cm

Paletowanie – 30 sztuk/paleta

Wymiar palety – 112x102x260 cm

– Waga palety+30 daszków 620 kg brutto

W komplecie śruby i kołki rozporowe do samodzielnego montażu daszka.

Moduł bazowy może być użyty jako samodzielne zadaszenie.

Szczegółowe informacje na temat systemów modułowych na stronie 22.



LIGHTLINE EXTENDABLE CANOPY-SYSTEM „L” BASIC STARTER PACK

Acrylic plate 4 mm.

transparent

satin white

satin blue

satin green

Construction of canopies:

| | | |
|---|--|---|
| Model I. Supporting legs – galvanized steel black powder coated RAL9010 Gutter, wall profile – galvanized aluminum powder coated RAL9010 | Model II. Supporting legs – stainless steel (V2A) Gutter, wall profile – anodized aluminum | Model III. Supporting legs – acid resistant steel (V4A) Gutter, wall profile – anodized aluminum |
|---|--|---|

Weight of canopies - 20 kg / pcs.

Size of packaging – 110x10x8 cm

Palletizing – 30 pcs./palette

Size of palette – 112x102x260 cm
– Weight of palette +30 canopies 620 kg brutto

Complete set for self assembly.

Basic module can be used as a stand alone canopy.
For more details about the extendable canopy-system look on page 22.



LIGHTLINE MODULARSYSTEM BASIS „L” BASISMODUL

Füllung – Acrylglas 4mm.

klar

satiniert weiß

satiniert blau

satiniert gruen

Konstruktion:

| | | |
|--|---|--|
| Modell I: Träger - Stahl Schwarz verzinkt, pulverbeschichtet RAL9010 Regenrinne, Wandprofil - Aluminium pulverbeschichtet RAL9010 | Modell II: Träger – Edelstahl (V2A) Regenrinne, Wandprofil - aus eloxiertem Aluminium | Modell III: Träger – Stahl mit suäre Widerstandsfähigkeit (V4A) Regenrinne, Wandprofil - aus eloxiertem Aluminium |
|--|---|--|

Gewicht - 20 kg

Abmessungen der Verpackung – 110x100x8cm

Paletteneinheit 30 Stück

Abmessungen der Palette – 112x102x260 cm
Gewicht der Palette 620 kg brutto

Komplett mit Schrauben und Dübel zur Selbstmontage.

Das Basismodul kann als Einzelvordach verwendet werden.
Für weitere information über Modulares Vordachsystem schen Sie die Seite 23.



LIGHTLINE SYSTEME MODULAIRE DE BASE L MODÈLE BASIC L

Réalisation des auvents – plaque acrylique 4 mm.

Clair

Satiné Blanc

Satiné Bleu

Satiné Vert

Construction des auvents:

| | | |
|--|---|--|
| Le modèle I. Supports – acier noir galvanisé, paint en pulvérisation RAL 9010 Goutière, profilé du près du mur – aluminium paint en pulvérisation RAL 9010 | Le modèle II. Supports en acier inoxydable (V2A) Goutière, profilé du près du mur – aluminium anodisé | Le modèle III. Supports - Acier resistant aux acides (V4A) Goutière, profilé du près du mur – aluminium anodisé |
|--|---|--|

Poids - 20 kg/pièce

Dimensions du colis - 110x100x8 cm

Palletisation - 30 pièces / palette

Dimension de la palette - 112x102x260 cm
Poids de la palette + 30 auvents 620 kg brut

Inclus les vis et les chevilles pour le montage individuel.

Le module standard peut être utilisé comme une marquise seule.
Details sur les systèmes modulaire a la page 23.

LIGHTLINE SYSTEM MODUŁOWY „L”

MODUŁ ROZSZERZENIOWY

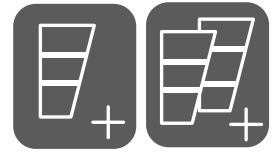

| Model I. | Model | | | Wypełnienie | Indeks | Lp. |
|-----------------------|--------------|--------|--------|--------------------|---------------|------------|
| | A (cm) | B (cm) | C (cm) | | | |
| Model II. | 81,6 | 95 | 17 | | 160541 | 61 |
| | | | | | 160543 | 62 |
| | | | | | 160545 | 63 |
| | | | | | 160547 | 64 |
| Model III. | 81,6 | 95 | 17 | | 170541 | 65 |
| | | | | | 170543 | 66 |
| | | | | | 170545 | 67 |
| | | | | | 170547 | 68 |
| Model III. | 81,6 | 95 | 17 | | 180541 | 69 |
| | | | | | 180543 | 70 |
| | | | | | 180545 | 71 |
| | | | | | 180547 | 72 |

Wypełnienie daszków - płyta akrylowa 4 mm.

przejrzysty
 satyna biała
 satyna niebieska
 satyna zielona

Konstrukcja daszków:

| | | |
|---|---|--|
| Model I. Nogi podporowe – stal czarna ocynkowana lakierowana proszkowo RAL9010 Rynna, profil przyścienny – aluminium | Model II. Nogi podporowe – stal nierdzewna (V2A) Rynna, profil przyścienny – aluminium anodowane | Model III. Nogi podporowe – stal kwasoodporna (V4A) Rynna, profil przyścienny – aluminium anodowane |
|---|---|--|

Waga daszków - 10 kg / sztuka

Wymiar opakowania – 100x85x8cm

Paletowanie – 30 sztuk/paleta

Wymiar palety – 102x87x260 cm
 – Waga palety+30 daszków 320 kg brutto

W komplecie śruby i kołki rozporowe do samodzielnego montażu daszka.

Szczegółowe informacje na temat systemów modułowych na stronie 22.



LIGHTLINE EXTENDABLE CANOPY-SYSTEM „L” EXTENSION KIT/MODULE

Acrylic plate 4 mm.

transparent

satin white

satin blue

satin green

Construction of canopies:

| | | |
|---|--|---|
| Model I. Supporting legs – galvanized steel black powder coated RAL9010 Gutter, wall profile – galvanized aluminum powder coated RAL9010 | Model II. Supporting legs – stainless steel (V2A) Gutter, wall profile – anodized aluminum | Model III. Supporting legs – acid resistant steel (V4A) Gutter, wall profile – anodized aluminum |
|---|--|---|

Weight of canopies - 10 kg / pcs.

Size of packaging – 100x85x8 cm

Palletizing – 30 pcs./palette

Size of palette – 102x87x260 cm
– Weight of palette +30 canopies 30 kg brutto

Complete set for self assembly.

For more details about the extendable canopy-system look on page 22.



LIGHTLINE MODULARSYSTEM „L” ERWEITERUNGS MODUL

Füllung – Acrylglas 4mm.

klar

satiniert weiß

satiniert blau

satiniert gruen

Konstruktion:

| | | |
|--|---|--|
| Modell I: Träger - Stahl Schwarz verzinkt, pulverbeschichtet RAL9010 Regenrinne, Wandprofil - Aluminium pulverbeschichtet RAL9010 | Modell II: Träger – Edelstahl (V2A) Regenrinne, Wandprofil - aus eloxiertem Aluminium | Modell III: Träger – Stahl mit suäre Widerstandsfähigkeit (V4A) Regenrinne, Wandprofil - aus eloxiertem Aluminium |
|--|---|--|

Gewicht - 10 kg

Abmessungen der Verpackung – 100x87x8cm

Paletteneinheit 30 Stück

Abmessungen der Palette – 102x87x260 cm
Gewicht der Palette 320 kg brutto

Komplett mit Schrauben und Dübel zur Selbstmontage.

Für weitere information über Modulares Vordachsystem schen Się die Seite 23.



LIGHTLINE SYSTEME MODULAIRE DE BASE L MODULE D'EXPANSION L

Réalisation des auvents – plaque acrylique 4 mm.

Clair

Satiné Blanc

Satiné Bleu

Satiné Vert

Construction des auvents:

| | | |
|---|--|---|
| Le modèle I. Supports – acier noir galvanisé, peint en pulvérisation RAL 9010 Gouttière, profilé du près du mur – aluminium peint en pulvérisation RAL 9010 | Le modèle II. Supports en acier inoxydable (V2A) Gouttière, profilé du près du mur – aluminium anodisé | Le modèle III. Supports - Acier resistant aux acides (V4A) Gouttière, profilé du près du mur – aluminium anodisé |
|---|--|---|

Poids - 10 kg/pièce

Dimensions du colis - 100x85x8 cm

Palletisation - 30 pièces / palette

Dimension de la palette - 102x87x260 cm
Poids de la palette + 30 auvents 320 kg brut

Inclus les vis et les chevilles pour le montage individuel.

Details sur les systemes modulaire a la page 23.

LIGHTLINE SYSTEM MODUŁOWY „XL”

MODUŁ BAZOWY

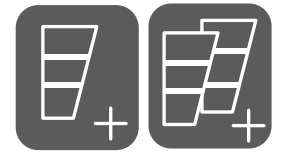
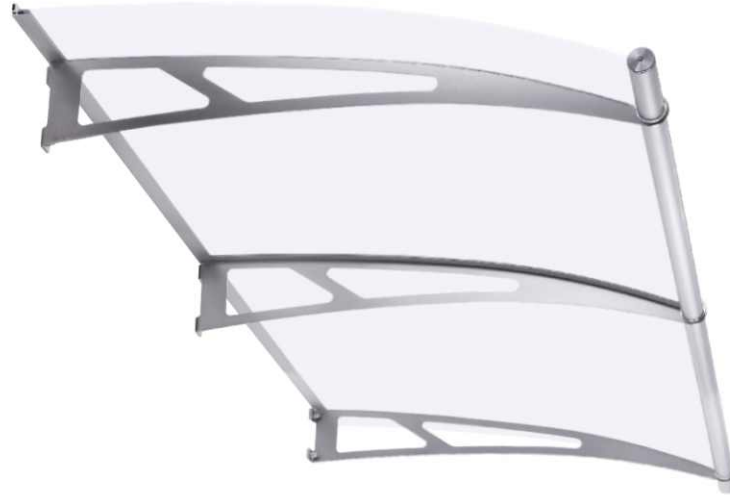

| Model I. | Model | | | Wypełnienie | Indeks | Lp. |
|----------------|--------|--------|--------|-------------|--------|-----|
| | A (cm) | B (cm) | C (cm) | | | |
| Model II. | 287,4 | 142 | 25 | | 162000 | 73 |
| | | | | | 162010 | 74 |
| | | | | | 162020 | 75 |
| | | | | | 162030 | 76 |
| Model III. | 287,4 | 142 | 25 | | 172000 | 77 |
| | | | | | 172010 | 78 |
| | | | | | 172020 | 79 |
| | | | | | 172030 | 80 |
| Model III. | 287,4 | 142 | 25 | | 182000 | 81 |
| | | | | | 182010 | 82 |
| | | | | | 182020 | 83 |
| | | | | | 182030 | 84 |

Wypełnienie daszków - płyta akrylowa 6 mm.

przejrzysty

satyna biała

satyna niebieska

satyna zielona

Konstrukcja daszków:

| | | |
|---|---|--|
| Model I. Nogi podporowe – stal czarna ocynkowana lakierowana proszkowo RAL9010 Rynna, profil przyścienny – aluminium | Model II. Nogi podporowe – stal nierdzewna (V2A) Rynna, profil przyścienny – aluminium anodowane | Model III. Nogi podporowe – stal kwasoodporna (V4A) Rynna, profil przyścienny – aluminium anodowane |
|---|---|--|

Waga daszków - 48 kg / sztuka

Wymiar opakowania – 150x138x3cm (akryl); 158x57x8 cm (komponenty)

Paletowanie – 30 sztuk/paleta

Wymiar palety – 152x140x105 cm (akryl); 160x59x255 cm (komponenty)
 – Waga palety + 30 daszków 1480 kg brutto

W komplecie śruby i kołki rozporowe do samodzielnego montażu daszka.

Moduł bazowy może być użyty jako samodzielne zadaszanie.
Szczegółowe informacje na temat systemów modułowych na stronie 22.



LIGHTLINE EXTENDABLE CANOPY-SYSTEM „XL“ BASIC STARTER PACK

Acrylic plate 6 mm.

transparent

satin white

satin blue

satin green

Construction of canopies:

| | | |
|---|--|---|
| Model I. Supporting legs – galvanized steel black powder coated RAL9010 Gutter, wall profile – galvanized aluminum powder coated RAL9010 | Model II. Supporting legs – stainless steel (V2A) Gutter, wall profile – anodized aluminum | Model III. Supporting legs – acid resistant steel (V4A) Gutter, wall profile – anodized aluminum |
|---|--|---|

Weight of canopies - 48 kg / pcs.

Size of packaging – 150x138x3 cm (acrylic); 158x57x8 cm (components)

Palletizing – 30 pcs./palette

Size of palette – 152x140x105 cm (acrylic); 160x59x255 cm (components)
– Weight of palette +30 canopies 1480 kg brutto

Complete set for self assembly.

Basic module can be used as a stand alone canopy.
For more details about the extendable canopy-system look on page 22.



LIGHTLINE MODULARSYSTEM BASIS „XL“ BASISMODUL

Füllung – Acrylglas 6 mm.

klar

satiniert weiß

satiniert blau

satiniert grün

Konstruktion:

| | | |
|--|---|--|
| Modell I: Träger - Stahl Schwarz verzinkt, pulverbeschichtet RAL9010 Regenrinne, Wandprofil - Aluminium pulverbeschichtet RAL9010 | Modell II: Träger - Edelstahl (V2A) Regenrinne, Wandprofil - aus eloxiertem Aluminium | Modell III: Träger - Stahl mit saure Widerstandsfähigkeit (V4A) Regenrinne, Wandprofil - aus eloxiertem Aluminium |
|--|---|--|

Gewicht 48 kg

Abmessung der Verpackung Träger und Profile – 150x138x3 cm (Acryl); 158x57x8 cm (Components)

Paletteneinheit 30 Stück

Abmessungen der Palette – 152x140x105 cm (Acryl); 160x59x255 cm (Components)
Gewicht der Palette 1480 kg brutto

Komplett mit Schrauben und Dübel zur Selbstmontage.

Das Basismodul kann als Einzelvordach verwendet werden.
Für weitere information über Modulares Vordachsystem sehen Sie die Seite 23.



LIGHTLINE SYSTEME MODULAIRE DE BASE XL MODÈLE BASIC L

Réalisation des auvents – plaque acrylique 6 mm.

Clair

Satiné Blanc

Satiné Bleu

Satiné Vert

Construction des auvents:

| | | |
|---|--|---|
| Le modèle I. Supports – acier noir galvanisé, peint en pulvérisation RAL 9010 Gouttière, profilé du près du mur – aluminium peint en pulvérisation RAL 9010 | Le modèle II. Supports en acier inoxydable (V2A) Gouttière, profilé du près du mur – aluminium anodisé | Le modèle III. Supports - Acier résistant aux acides (V4A) Gouttière, profilé du près du mur – aluminium anodisé |
|---|--|---|

Poids - 48 kg/pièce

Dimensions du colis - 150x138x3cm (acrylique); 158x57x8cm (composants)

Palletisation - 30 pièces / palette

Dimension de la palette - 152x140x105cm (acrylique); 160x59x255cm (composants)
- poids de la palette + 30 auvents 1480 kg brut

Inclus les vis et les chevilles pour le montage individuel.

Le module standard peut être utilisé comme une marquise seule.
Détails sur les systèmes modulaire à la page 23.

LIGHTLINE SYSTEM MODUŁOWY „XL”

MODUŁ ROZSZERZENIOWY

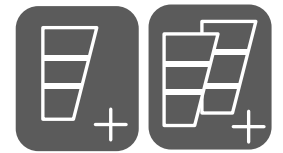
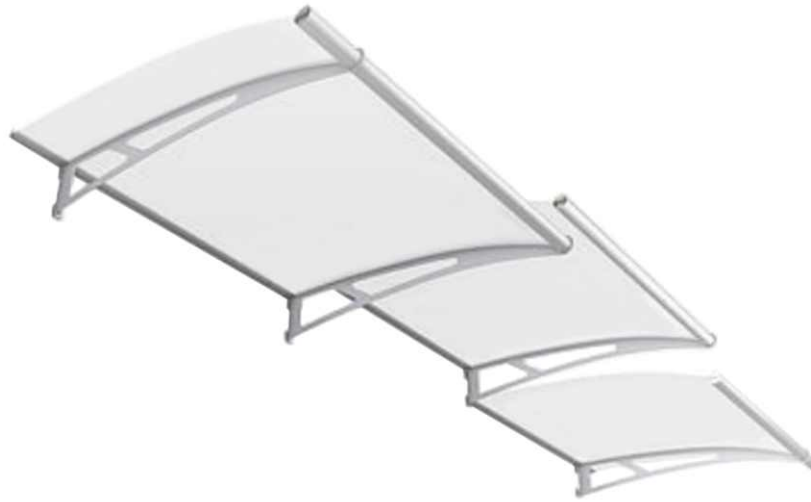

| Model I. | Model | | | Wypełnienie | Indeks | Lp. |
|----------------|--------|--------|--------|-------------|--------|-----|
| | A (cm) | B (cm) | C (cm) | | | |
| Model II. | 121,6 | 142 | 25 | | 160001 | 85 |
| | | | | | 160011 | 86 |
| | | | | | 160021 | 87 |
| | | | | | 160031 | 88 |
| Model III. | 121,6 | 142 | 25 | | 172001 | 89 |
| | | | | | 172011 | 90 |
| | | | | | 172021 | 91 |
| | | | | | 172031 | 92 |
| Model III. | 121,6 | 142 | 25 | | 182001 | 93 |
| | | | | | 182011 | 94 |
| | | | | | 182021 | 95 |
| | | | | | 182031 | 96 |

Wypełnienie daszków - płyta akrylowa 6 mm.

przejrzysty
 satyna biała
 satyna niebieska
 satyna zielona

Konstrukcja daszków:

| | | |
|---|---|--|
| Model I. Nogi podporowe – stal czarna ocynkowana lakierowana proszkowo RAL9010 Rynna, profil przyścienny – aluminium | Model II. Nogi podporowe – stal nierdzewna (V2A) Rynna, profil przyścienny – aluminium anodowane | Model III. Nogi podporowe – stal kwasoodporna (V4A) Rynna, profil przyścienny – aluminium anodowane |
|---|---|--|

Waga daszków -25 kg / sztuka

Wymiar opakowania – 150x138x3cm (akryl); 148x46x8 cm (komponenty)

Paletowanie – 30 sztuk/paleta

Wymiar palety – 145x125x105 cm (akryl); 150x48x255 cm (komponenty)
 – Waga palety+30 daszków 790 kg brutto

W komplecie śruby i kołki rozporowe do samodzielnego montażu daszka.

Szczegółowe informacje na temat systemów modułowych na stronie 22.



LIGHTLINE EXTENDABLE CANOPY-SYSTEM „XL“ EXTENSION KIT/MODULE

Acrylic plate 6 mm.

transparent

satin white

satin blue

satin green

Construction of conopies:

| | | |
|---|--|---|
| Model I. Supporting legs – galvanized steel black powder coated RAL9010 Gutter, wall profile – galvanized aluminum powder coated RAL9010 | Model II. Supporting legs – stainless steel (V2A) Gutter, wall profile – anodized aluminum | Model III. Supporting legs – acid resistant steel (V4A) Gutter, wall profile – anodized aluminum |
|---|--|---|

Weight of conopies - 25 kg / pcs.

Size of packaging – 150x138x3 cm (acrylic); 148x46x8 cm (components)

Palletizing – 30 pcs./palette

Size of palette – 145x125x105 cm (acrylic); 150x48x255 cm (components)
– Weight of palette +30 conopies 790 kg brutto

Complete set for self assembly.

For more details about the extendable conopy-system look on page 22.



LIGHTLINE MODULARSYSTEM „XL“ ERWEITERUNGS MODUL

Füllung – Acrylglas 6 mm.

klar

satiniert weiß

satiniert blau

satiniert gruen

Konstruktion:

| | | |
|--|---|--|
| Modell I: Träger - Stahl Schwarz verzinkt, pulverbeschichtet RAL9010 Regenrinne, Wandprofil - Aluminium pulverbeschichtet RAL9010 | Modell II: Träger – Edelstahl (V2A) Regenrinne, Wandprofil - aus eloxiertem Aluminium | Modell III: Träger – Stahl mit suäre Widerstandsfähigkeit (V4A) Regenrinne, Wandprofil - aus eloxiertem Aluminium |
|--|---|--|

Gewicht 25 kg

Abmessung der Verpackung Träger und Profile – 150x138x3 cm (Acryl); 148x46x8 cm (Components)

Paletteneinheit 30 Stück

Abmessungen der Palette – 145x125x105 cm (Acryl); 150x48x255 cm (Components)
Gewicht der Palette 790 kg brutto

Komplett mit Schrauben und Dübel zur Selbstmontage.

Für weitere information über Modulares Vordachsystem schen Sie die Seite 23.



LIGHTLINE SYSTEME MODULAIRE DE BASE XL MODULE D'EXPANSION XL

Réalisation des auvents – plaque acrylique 6 mm.

Clair

Satiné Blanc

Satiné Bleu

Satiné Vert

Construction des auvents:

| | | |
|---|--|---|
| Le modèle I. Supports – acier noir galvanisé, peint en pulvérisation RAL 9010 Gouttière, profilé du près du mur – aluminium peint en pulvérisation RAL 9010 | Le modèle II. Supports en acier inoxydable (V2A) Gouttière, profilé du près du mur – aluminium anodisé | Le modèle III. Supports - Acier resistant aux acides (V4A) Gouttière, profilé du près du mur – aluminium anodisé |
|---|--|---|

Poids - 25 kg/pièce

Dimensions du colis - 150x138x3cm (acrylique); 148x46x8cm (composants)

Palletisation - 30 pièces / palette

Dimension de la palette - 145x125x105cm (acrylique); 150x48x255cm (composants)
- poids de la palette + 30 auvents 790 kg brut

Inclus les vis et les chevilles pour le montage individuel.

Details sur les systemes modulaire a la page 23.

LIGHTLINE SYSTEM MODUŁOWY



| Rysunek | DŁUGOŚCI DASZKA MODUŁOWEGO L | | DŁUGOŚCI DASZKA MODUŁOWEGO XL | |
|---------|------------------------------|--------------------------------|-------------------------------|--------------------------------|
| | Warianty łączenia modułów | Całkowita szerokość zadaszenia | Warianty łączenia modułów | Całkowita szerokość zadaszenia |
| | Moduł bazowy (A1 + A2) | 1916 mm | Moduł bazowy (A1 + A2) | 2874 mm |
| | +1 Moduł rozszerzeniowy (B) | 2732 mm | +1 Moduł rozszerzeniowy (B) | 4092 mm |
| | +2 Moduł rozszerzeniowy (B) | 3548 mm | +2 Moduł rozszerzeniowy (B) | 5310 mm |
| | +3 Moduł rozszerzeniowy (B) | 4364 mm | +3 Moduł rozszerzeniowy (B) | 6528 mm |
| | +4 Moduł rozszerzeniowy (B) | 5180 mm | +4 Moduł rozszerzeniowy (B) | 7746 mm |
| | +5 Moduł rozszerzeniowy (B) | 5996 mm | +5 Moduł rozszerzeniowy (B) | 8964 mm |
| | Każdy dodatkowy moduł (B) | +816 mm | Każdy dodatkowy moduł (B) | +1218 mm |

UWAGA!!! Moduł rozszerzeniowy może być stosowany tylko w połączeniu z modułem bazowym.

Personalizacja odprowadzania wody.

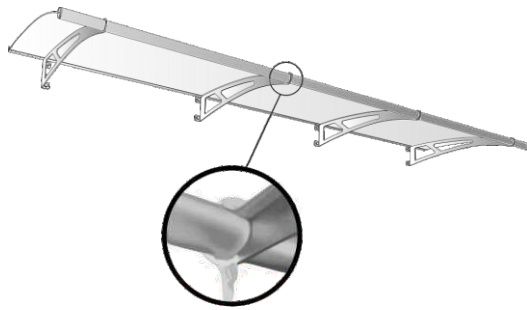

Możemy dostosować odprowadzanie wody do własnych potrzeb.

Standardowo woda odprowadzana jest na krańcach zadaszenia oraz na każdym łączeniu modułów przy profilu rynnowym.

Opcjonalne złącze modułu umożliwia odprowadzanie wody tylko na krańcach zadaszenia.

| | Wariant | Kod produktu |
|--|-----------|--------------|
| | Wersja L | 170558 |
| | Wersja XL | 170548 |

LIGHTLINE EXTENDABLE CANOPY-SYSTEM



| Draft | LENGHT OF DASZKA EXTENDABLE CANOPY-SYSTEM L | | LENGHT OF DASZKA EXTENDABLE CANOPY-SYSTEM XL | |
|-------|---|-----------------|--|-----------------|
| | Variations of possible connection | Width of canopy | Variations of possible connection | Width of canopy |
| | Basic starter pack (A1 + A2) | 1916 mm | Basic starter pack (A1 + A2) | 2874 mm |
| | +1 Extension kit/ module (B) | 2732 mm | +1 Extension kit/ module (B) | 4092 mm |
| | +2 Extension kit/ module (B) | 3548 mm | +2 Extension kit/ module (B) | 5310 mm |
| | +3 Extension kit/ module (B) | 4364 mm | +3 Extension kit/ module (B) | 6528 mm |
| | +4 Extension kit/ module (B) | 5180 mm | +4 Extension kit/ module (B) | 7746 mm |
| | +5 Extension kit/ module (B) | 5996 mm | +5 Extension kit/ module (B) | 8964 mm |
| | Every additional module (B) | +816 mm | Every additional module (B) | +1218 mm |

WARNING!!! Expansion kit /module may be only used in connection to basic starter pack.

Customization of water draining

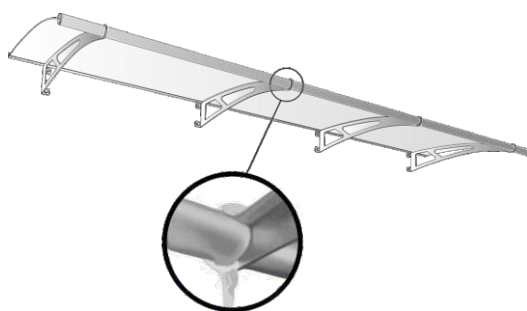

We can adapt draining of water to own needs. In standard draining of water is at the end of canopy and on each connection of modules.

As a option connection of module allows draining of water only at the end of canopy.

| | Version | Index |
|--|------------|--------|
| | Version L | 170558 |
| | Version XL | 170548 |

LIGHTLINE MODULARSYSTEM



| Zeichnung | LÄNGE VON MODULARENVORDACH L | | LÄNGE VON MODULARENVORDACH XL | |
|-----------|------------------------------|----------------|-------------------------------|----------------|
| | Verbindungs Variante | Vordach breite | Verbindungs Variante | Vordach breite |
| | Basismodul (A1 + A2) | 1916mm | Basismodul (A1 + A2) | 2874 mm |
| | +1 Erweiterungs modul (B) | 2732mm | +1 Erweiterungs modul (B) | 4092 mm |
| | +2 Erweiterungs modul (B) | 3548 mm | +2 Erweiterungs modul (B) | 5310 mm |
| | +3 Erweiterungs modul (B) | 4364 mm | +3 Erweiterungs modul (B) | 6528 mm |
| | +4 Erweiterungs modul (B) | 5180 mm | +4 Erweiterungs modul (B) | 7746 mm |
| | +5 Erweiterungs modul (B) | 5996 mm | +5 Erweiterungs modul (B) | 8964 mm |
| | Jedes weitere Modul (B) | +816 mm | Jedes weitere Modul (B) | +1218 mm |

ACHTUNG !!! Erweiterungsmodul darf nur in Verbindung mit der Basismodul verwendet werden.

Personalisierung von Entwässerung

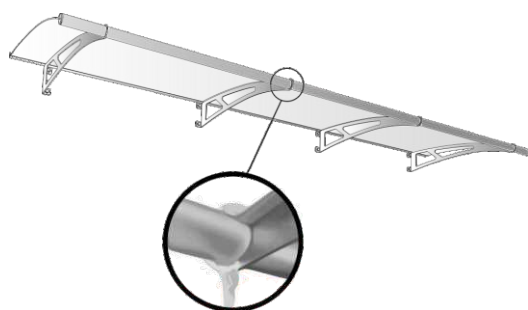

Wir können Entwässerung an Ihre Bedürfnisse anpassen. Normalerweise wird Wasser am Rand des Daches und am Verbindung von Module ausgetragen.

Optional Modulanschluss ermöglicht Entwässerung nur an den Enden des Daches.

| | Version | Index |
|--|------------|--------|
| | Version L | 170558 |
| | Version XL | 170548 |

LIGHTLINE SYSTEME MODULAIRE DE BASE



| Dessin | LONGEUR DE LA MARQUISE MODULAIRE L | | LONGEUR DE LA MARQUISE MODULAIRE XL | |
|--------|------------------------------------|--------------------------|-------------------------------------|--------------------------|
| | Les options de raccords des | Largeur total de toiture | Les options de raccords des | Largeur total de toiture |
| | Module de base (A1 + A2) | 1916mm | Module de base (A1 + A2) | 2874 mm |
| | +1 Module d'extension (B) | 2732mm | +1 Module d'extension (B) | 4092 mm |
| | +2 Module d'extension (B) | 3548 mm | +2 Module d'extension (B) | 5310 mm |
| | +3 Module d'extension (B) | 4364 mm | +3 Module d'extension (B) | 6528 mm |
| | +4 Module d'extension (B) | 5180 mm | +4 Module d'extension (B) | 7746 mm |
| | +5 Module d'extension (B) | 5996 mm | +5 Module d'extension (B) | 8964 mm |
| | Chaque module supplémentaire (B) | +816 mm | Chaque module supplémentaire (B) | +1218 mm |

ATTENTION! Module d'extension peut être utilisé que en combinaison avec module de base.

Personnalisation de l'écoulement d'eau.

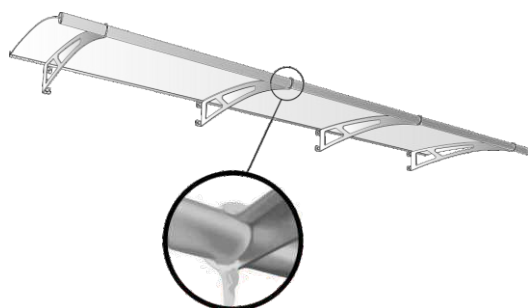

Nous pouvons personnaliser l'écoulement d'eau à leurs propres besoins. En standard l'eau est évacuée sur les bords de la toiture et sur chaque combinaison des modules au bord de la gouttière.

En option le raccord de module permet l'écoulement de l'eau que au bords de la toiture.

| | Option | Code du produit |
|--|------------|-----------------|
| | Version L | 170558 |
| | Version XL | 170548 |

LIGHTLINE GL1500



| Model I. | Model | | | Wypełnienie | Indeks | Lp. |
|-----------------------|--------|--------|--------|-------------|--------|-----|
| | A (cm) | B (cm) | C (cm) | | | |
| Model II. | 148 | 91 | 26 | | 160676 | 97 |
| | | | | | 160677 | 98 |
| | | | | | 160678 | 99 |
| | | | | | 160679 | 100 |
| Model III. | 148 | 91 | 26 | | 170676 | 101 |
| | | | | | 170677 | 102 |
| | | | | | 170678 | 103 |
| | | | | | 170679 | 104 |
| Model III. | 148 | 91 | 26 | | 180676 | 105 |
| | | | | | 180677 | 106 |
| | | | | | 180678 | 107 |
| | | | | | 180679 | 108 |

Wypełnienie daszków - płyta akrylowa 4 mm.

przejrzysty

satyna biała

satyna niebieska

satyna zielona

Konstrukcja daszków:

| Model I. | Model II. | Model III. |
|--|---|---|
| Nogi podporowe – stal czarna ocynkowana lakierowana proszkowo RAL9010 Rynna – aluminium lakierowane proszkowo RAL9010 | Nogi podporowe – stal nierdzewna (V2A) Rynna – aluminium anodowane | Nogi podporowe – stal kwasoodporna (V4A) Rynna – aluminium anodowane |

Waga daszków - 23kg / sztuka

Wymiar opakowania – 152x95x8cm

Paletowanie – 30 sztuk/paleta

Wymiar palety – 154x97x260 cm
– Waga palety+30 daszków 710 kg brutto

W komplecie śruby i kołki rozporowe do samodzielnego montażu daszka.



LIGHTLINE GL1500

Acrylic plate 4 mm.

transparent

satin white

satin blue

satin green

Construction of conopies:

| | | |
|---|---|---|
| Model I. Supporting legs – galvanized steel black powder coated RAL9010 Gutter – galvanized aluminum powder coated RAL9010 | Model II. Supporting legs – stainless steel (V2A) Gutter – anodized aluminum | Model III. Supporting legs – acid resistant steel (V4A) Gutter – anodized aluminum |
|---|---|---|

Weight of conopies - 23 kg / pcs.

Size of packaging – 152x95x8 cm

Palletizing – 30 pcs./palette

Size of palette – 154x97x260 cm

– Weight of palette +30 conopies 710 kg brutto

Complete set for self assembly.



LIGHTLINE GL1500

Füllung – Acrylglas 4mm.

klar

satiniert weiß

satiniert blau

satiniert grün

Konstruktion:

| | | |
|--|---|--|
| Modell I: Träger - Stahl Schwarz verzinkt, pulverbeschichtet RAL9010 Regenrinne - Aluminium pulverbeschichtet RAL9010 | Modell II: Träger – Edelstahl (V2A) Regenrinne - aus eloxiertem Aluminium | Modell III: Träger – Stahl mit saure Widerstandsfähigkeit (V4A) Regenrinne - aus eloxiertem Aluminium |
|--|---|--|

Gewicht - 23 kg

Abmessungen der Verpackung – 152x95x8cm

Paletteneinheit 30 Stück

Abmessungen der Palette – 154x97x260cm

Gewicht der Palette 710 kg brutto

Komplett mit Schrauben und Dübel zur Selbstmontage.



LIGHTLINE GL1500

Réalisation des auvents – plaque acrylique 4 mm.

Clair

Satiné Blanc

Satiné Bleu

Satiné Vert

Construction des auvents:

| | | |
|--|---|---|
| Le modèle I. Supports – acier noir galvanisé, peint en pulvérisation RAL 9010 Gouttière – aluminium peint en pulvérisation RAL 9010 | Le modèle II. Supports en acier inoxydable (V2A) Gouttière – aluminium anodisé | Le modèle III. Supports - Acier résistant aux acides (V4A) Gouttière, profilé du près du mur – aluminium anodisé |
|--|---|---|

Poids - 23 kg/pièce

Dimensions du colis - 152x95x8 cm

Palletisation - 30 pièces / palette

Dimension de la palette - 154x97x260 cm

Poids de la palette + 30 auvents 710 kg brut

Inclus les vis et les chevilles pour le montage individuel.

LIGHTLINE RL1500

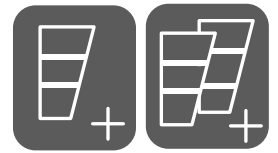

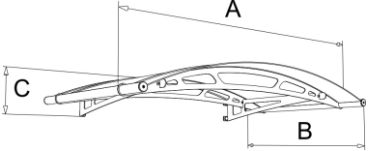
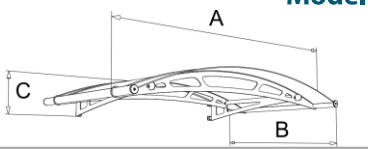
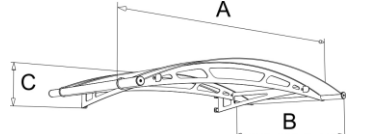
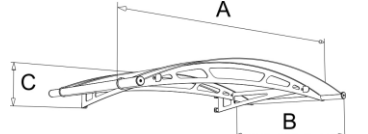
|  Model I. | Model | | | Wypełnienie | Indeks | Lp. |
|--|--------|--------|--------|-------------|--------|-----|
| | A (cm) | B (cm) | C (cm) | | | |
|  Model II. | 148 | 91 | 24 | | 160664 | 109 |
| | | | | | 160665 | 110 |
| | | | | | 160666 | 111 |
| | | | | | 160667 | 112 |
|  Model III. | 148 | 91 | 24 | | 170664 | 113 |
| | | | | | 170665 | 114 |
| | | | | | 170666 | 115 |
| | | | | | 170667 | 116 |
|  Model III. | 148 | 91 | 24 | | 180664 | 117 |
| | | | | | 180665 | 118 |
| | | | | | 180666 | 119 |
| | | | | | 180667 | 120 |

 **Wypełnienie daszków** - płyta akrylowa 4 mm.

przejrzysty

satyna biała

satyna niebieska

satyna zielona

Konstrukcja daszków:

| | | |
|---|---|--|
| Model I. Nogi podporowe – stal czarna ocynkowana lakierowana proszkowo RAL9010 Rynna – aluminium lakierowane proszkowo RAL9010 | Model II. Nogi podporowe – stal nierdzewna (V2A) Rynna – aluminium anodowane | Model III. Nogi podporowe – stal kwasoodporna (V4A) Rynna – aluminium anodowane |
|---|---|--|

Waga daszków - 23kg / sztuka

Wymiar opakowania – 152x95x8cm

Paletowanie – 30 sztuk/paleta

Wymiar palety – 154x97x260 cm
 – Waga palety+30 daszków 710 kg brutto

W komplecie śruby i kołki rozporowe do samodzielnego montażu daszka.



LIGHTLINE RL1500

Acrylic plate 4 mm.

transparent

satin white

satin blue

satin green

Construction of conopies:

| | | |
|---|---|---|
| Model I. Supporting legs – galvanized steel black powder coated RAL9010 Gutter – galvanized aluminum powder coated RAL9010 | Model II. Supporting legs – stainless steel (V2A) Gutter – anodized aluminum | Model III. Supporting legs – acid resistant steel (V4A) Gutter – anodized aluminum |
|---|---|---|

Weight of conopies - 23 kg / pcs.

Size of packaging – 152x95x8 cm

Palletizing – 30 pcs./palette

Size of palette – 154x97x260 cm
– Weight of palette +30 conopies 710 kg brutto

Complete set for self assembly.



LIGHTLINE RL1500

Füllung – Acrylglas 4mm.

klar

satiniert weiß

satiniert blau

satiniert gruen

Konstruktion:

| | | |
|--|---|--|
| Modell I: Träger - Stahl Schwarz verzinkt, pulverbeschichtet RAL9010 Regenrinne - Aluminium pulverbeschichtet RAL9010 | Modell II: Träger – Edelstahl (V2A) Regenrinne - aus eloxiertem Aluminium | Modell III: Träger – Stahl mit suäre Widerstandsfähigkeit (V4A) Regenrinne - aus eloxiertem Aluminium |
|--|---|--|

Gewicht - 23 kg

Abmessungen der Verpackung – 152x95x8cm

Paletteneinheit 30 Stück

Abmessungen der Palette – 154x97x260cm
Gewicht der Palette 710 kg brutto

Komplett mit Schrauben und Dübel zur Selbstmontage.



LIGHTLINE RL1500

Réalisation des auvents – plaque acrylique 4 mm.

Clair

Satiné Blanc

Satiné Bleu

Satiné Vert

Construction des auvents:

| | | |
|--|---|---|
| Le modèle I. Supports – acier noir galvanisé, paint en pulvérisation RAL 9010 Gouttière – aluminium paint en pulvérisation RAL 9010 | Le modèle II. Supports en acier inoxydable (V2A) Gouttière – aluminium anodisé | Le modèle III. Supports - Acier résistant aux acides (V4A) Gouttière, profilé du près du mur – aluminium anodisé |
|--|---|---|

Poids - 23 kg/pièce

Dimensions du colis - 152x95x8 cm

Palletisation - 30 pièces / palette

Dimension de la palette - 154x97x260 cm
Poids de la palette + 30 auvents 710 kg brut

Inclus les vis et les chevilles pour le montage individuel.

LIGHTLINE RL1900

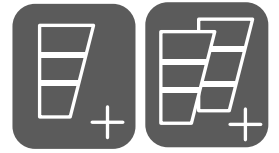

| Model I. | Model | | | Wypełnienie | Indeks | Lp. |
|-------------------|--------------|--------|--------|------------------------|---------------|------------|
| | A (cm) | B (cm) | C (cm) | | | |
| Model II. | 190 | 91 | 24 | | 160668 | 121 |
| | | | | | 160669 | 122 |
| | | | | | 160670 | 123 |
| | | | | | 160671 | 124 |
| Model III. | 190 | 91 | 24 | | 170668 | 125 |
| | | | | | 170669 | 126 |
| | | | | | 170670 | 127 |
| | | | | | 170671 | 128 |
| Model III. | 190 | 91 | 24 | | 180668 | 129 |
| | | | | | 180669 | 130 |
| | | | | | 180670 | 131 |
| | | | | | 180671 | 132 |

Wypełnienie daszków - płyta akrylowa 4 mm.

- przejrzysty
 satyna biała
 satyna niebieska
 satyna zielona

Konstrukcja daszków:

| | | |
|---|---|--|
| Model I. Nogi podporowe – stal czarna ocynkowana lakierowana proszkowo RAL9010 Rynna – aluminium lakierowane proszkowo RAL9010 | Model II. Nogi podporowe – stal nierdzewna (V2A) Rynna – aluminium anodowane | Model III. Nogi podporowe – stal kwasoodporna (V4A) Rynna – aluminium anodowane |
|---|---|--|

Waga daszków - 27 kg / sztuka

Wymiar opakowania – 197x91x8 cm

Paletowanie – 30 sztuk/paleta

Wymiar palety – 199x93x180 cm
 – Waga palety+30 daszków 840 kg brutto

W komplecie śruby i kołki rozporowe do samodzielnego montażu daszka.



LIGHTLINE RL1900

Acrylic plate 4 mm.

transparent

satin white

satin blue

satin green

Construction of conopies:

| | | |
|---|---|---|
| Model I. Supporting legs – galvanized steel black powder coated RAL9010 Gutter – galvanized aluminum powder coated RAL9010 | Model II. Supporting legs – stainless steel (V2A) Gutter – anodized aluminum | Model III. Supporting legs – acid resistant steel (V4A) Gutter – anodized aluminum |
|---|---|---|

Weight of conopies - 27 kg / pcs.

Size of packaging – 197x91x8 cm

Palletizing – 30 pcs./palette

Size of palette – 199x93x180 cm
– Weight of palette +30 conopies 840 kg brutto

Complete set for self assembly.



LIGHTLINE RL1900

Füllung – Acrylglas 4mm.

klar

satiniert weiß

satiniert blau

satiniert gruen

Konstruktion:

| | | |
|--|---|--|
| Modell I: Träger - Stahl Schwarz verzinkt, pulverbeschichtet RAL9010 Regenrinne - Aluminium pulverbeschichtet RAL9010 | Modell II: Träger – Edelstahl (V2A) Regenrinne - aus eloxiertem Aluminium | Modell III: Träger – Stahl mit suäre Widerstandsfähigkeit (V4A) Regenrinne - aus eloxiertem Aluminium |
|--|---|--|

Gewicht - 27 kg

Abmessungen der Verpackung – 197x91x8cm

Paletteneinheit 30 Stück

Abmessungen der Palette – 199x93x180cm
Gewicht der Palette 840 kg brutto

Komplett mit Schrauben und Dübel zur Selbstmontage.



LIGHTLINE RL1900

Réalisation des auvents – plaque acrylique 4 mm.

Clair

Satiné Blanc

Satiné Bleu

Satiné Vert

Construction des auvents:

| | | |
|--|---|---|
| Le modèle I. Supports – acier noir galvanisé, peint en pulvérisation RAL 9010 Gouttière – aluminium peint en pulvérisation RAL 9010 | Le modèle II. Supports en acier inoxydable (V2A) Gouttière – aluminium anodisé | Le modèle III. Supports - Acier résistant aux acides (V4A) Gouttière, profilé du près du mur – aluminium anodisé |
|--|---|---|

Poids - 27 kg/pièce

Dimensions du colis - 197x91x8 cm









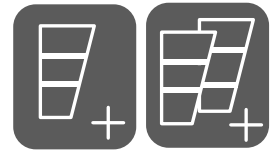

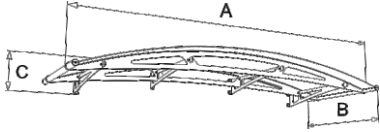
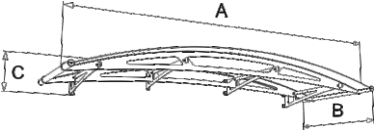
Palletisation - 30 pièces / palette

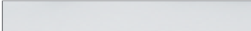
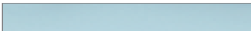
Dimension de la palette - 199x93x180 cm
Poids de la palette + 30 auvents 840 kg brut

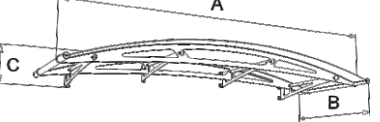
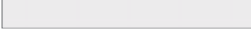
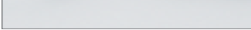
Inclus les vis et les chevilles pour le montage individuel.

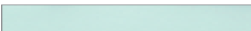
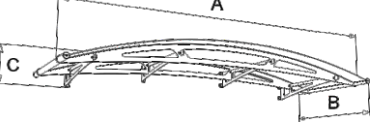
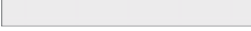
LIGHTLINE RL2500

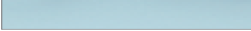

|  Model I. | Model | | | Wypełnienie | Indeks | Lp. |
|--|--------------|--------|--------|--|---------------|------------|
| | A (cm) | B (cm) | C (cm) | | | |
|  Model II. | 248 | 91 | 24 |  | 160672 | 133 |
| | | | |  | 160673 | 134 |
| | | | |  | 160674 | 135 |
| | | | |  | 160675 | 136 |
|  Model III. | 248 | 91 | 24 |  | 170672 | 137 |
| | | | |  | 170673 | 138 |
| | | | |  | 170674 | 139 |
| | | | |  | 170675 | 140 |
|  Model III. | 248 | 91 | 24 |  | 180672 | 141 |
| | | | |  | 180673 | 142 |
| | | | |  | 180674 | 143 |
| | | | |  | 180675 | 144 |

 **Wypełnienie daszków** - płyta akrylowa 4 mm.

przezroczysty

satyna biała

satyna niebieska

satyna zielona

Konstrukcja daszków:

| | | |
|---|---|--|
| Model I. Nogi podporowe – stal czarna ocynkowana lakierowana proszkowo RAL9010 Rynna – aluminium lakierowane proszkowo RAL9010 | Model II. Nogi podporowe – stal nierdzewna (V2A) Rynna – aluminium anodowane | Model III. Nogi podporowe – stal kwasoodporna (V4A) Rynna – aluminium anodowane |
|---|---|--|

Waga daszków - 49 kg / sztuka

Wymiar opakowania – 255x9x8cm

Paletowanie – 30 sztuk/paleta

Wymiar palety – 257x93x180 cm
 – Waga palety+30 daszków 1500 kg brutto

W komplecie śruby i kołki rozporowe do samodzielnego montażu daszka.



LIGHTLINE RL2500

Acrylic plate 4 mm.

transparent

satin white

satin blue

satin green

Construction of conopies:

| | | |
|---|---|---|
| Model I. Supporting legs – galvanized steel black powder coated RAL9010 Gutter – galvanized aluminum powder coated RAL9010 | Model II. Supporting legs – stainless steel (V2A) Gutter – anodized aluminum | Model III. Supporting legs – acid resistant steel (V4A) Gutter – anodized aluminum |
|---|---|---|

Weight of conopies - 49 kg / pcs.

Size of packaging – 255x91x8 cm

Palletizing – 30 pcs./palette

Size of palette – 257x93x180 cm

– Weight of palette +30 conopies 1500 kg brutto

Complete set for self assembly.



LIGHTLINE RL2500

Füllung – Acrylglas 4mm.

klar

satiniert weiß

satiniert blau

satiniert gruen

Konstruktion:

| | | |
|--|---|--|
| Modell I: Träger - Stahl Schwarz verzinkt, pulverbeschichtet RAL9010 Regenrinne - Aluminium pulverbeschichtet RAL9010 | Modell II: Träger – Edelstahl (V2A) Regenrinne - aus eloxiertem Aluminium | Modell III: Träger – Stahl mit suäre Widerstandsfähigkeit (V4A) Regenrinne - aus eloxiertem Aluminium |
|--|---|--|

Gewicht - 49 kg

Abmessungen der Verpackung – 255x91x8cm

Paletteneinheit 30 Stück

Abmessungen der Palette – 257x93x180cm

Gewicht der Palette 1500 kg brutto

Komplett mit Schrauben und Dübel zur Selbstmontage.



LIGHTLINE RL2500

Réalisation des auvents – plaque acrylique 4 mm.

Clair

Satiné Blanc

Satiné Bleu

Satiné Vert

Construction des auvents:

| | | |
|--|---|---|
| Le modèle I. Supports – acier noir galvanisé, paint en pulvérisation RAL 9010 Gouttière – aluminium paint en pulvérisation RAL 9010 | Le modèle II. Supports en acier inoxydable (V2A) Gouttière – aluminium anodisé | Le modèle III. Supports - Acier resistant aux acides (V4A) Gouttière, profilé du près du mur – aluminium anodisé |
|--|---|---|

Poids - 49 kg/pièce

Dimensions du colis - 255x91x8 cm

Palletisation - 30 pièces / palette







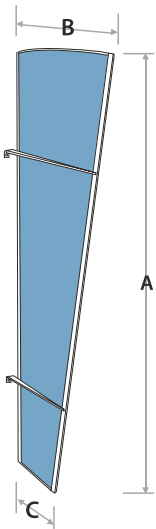
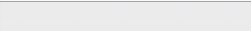
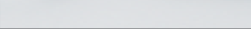

Dimension de la palette - 257x93x180 cm

Poids de la palette + 30 auvents 1500 kg brut

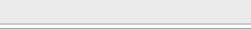
Inclus les vis et les chevilles pour le montage individuel.

LIGHTLINE ŚCIANKA L

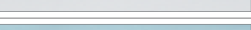
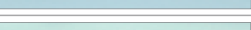

|  | Model | | | Wypełnienie | Indeks | Lp. |
|--|--------|--------|--------|--|--------|-----|
| | A (cm) | B (cm) | C (cm) | | | |
| | 167 | 62 | 32 |  | 160930 | 145 |
| | | | |  | 160931 | 146 |
| | | | |  | 160932 | 147 |
| | | | |  | 160933 | 148 |
| | 167 | 62 | 32 |  | 170930 | 149 |
| | | | |  | 170931 | 150 |
| | | | |  | 170932 | 151 |
| | | | |  | 170933 | 152 |
| | 167 | 62 | 32 |  | 180930 | 153 |
| | | | |  | 180931 | 154 |
| | | | |  | 180932 | 155 |
| | | | |  | 180933 | 156 |

 **Wypełnienie ścianek** - płyta akrylowa 6 mm.

przezroczysty

satyna biała

satyna niebieska

satyna zielona

Konstrukcja ścianek:

| Model I. | Model II. | Model III. |
|--|---|---|
| Uchwyty mocujące – stal czarna ocynkowana lakierowana proszkowo RAL9010 Profil aluminiowy lakierowany proszkowo RAL9010 | Uchwyty mocujące – stal nierdzewna (V2A) Profil aluminiowy anodowany | Uchwyty mocujące – stal kwasoodporna (V4A) Profil aluminiowy anodowany |

Waga ścianek - 10 kg / sztuka

Wymiar opakowania – 169x64x4cm

Paletowanie – 35 sztuk/paleta

Wymiar palety – 171x64x160 cm
 – Waga palety+35 ścianek 370 kg brutto

W komplecie śruby i kołki rozporowe do samodzielnego montażu daszka.



LIGHTLINE SIDE PANEL L

Acrylic plate 6 mm.

transparent

satin white

satin blue

satin green

Construction of side panel:

| | | |
|---|--|--|
| Model I. Supporting legs – galvanized steel black powder coated RAL9010 Powder coated aluminum profile RAL9010 | Model II. Supporting legs – stainless steel (V2A) Anodized aluminum profile | Model III. Supporting legs – acid resistant steel (V4A) Anodized aluminum profile |
|---|--|--|

Weight of side panel - 10 kg / pcs.

Size of packaging – 169x64x4 cm

Palletizing – 35 pcs./palette

Size of palette – 171x64x160 cm
– Weight of palette +35 side panels 370 kg brutto

Complete set for self assembly.



LIGHTLINE SEITENTEIL L

Füllung – Acrylglas 6 mm.

klar

satiniert weiß

satiniert blau

satiniert gruen

Konstruktion:

| | | |
|---|--|--|
| Modell I: Träger – Stahl Schwarz verzinkt, pulverbeschichtet RAL9010 Aluminiumprofil pulverbeschichtet RAL9010 | Modell II: Träger – Edelstahl (V2A) Aluminiumprofil anodaized | Modell III: Träger – Stahl mit suäre Widerstandsfähigkeit (V4A) Aluminiumprofil anodaized |
|---|--|--|

Gewicht - 10 kg

Abmessungen der Verpackung – 169x64x4 cm

Paletteneinheit 35 Stück

Abmessungen der Palette – 171x64x160 cm
Gewicht der Palette 370 kg brutto

Komplett mit Schrauben und Dübel zur Selbstmontage.



LIGHTLINE PAROI L

Réalisation des auvents – plaque acrylique 6 mm.

Clair

Satiné Blanc

Satiné Bleu

Satiné Vert

Construction des auvents:

| | | |
|---|--|---|
| Le modèle I. Supports – acier noir galvanisé, peint en pulvérisation RAL 9010 Gouttière, profilé du près du mur – aluminium peint en pulvérisation RAL 9010 | Le modèle II. Supports en acier inoxydable (V2A) Gouttière, profilé du près du mur – aluminium anodisé | Le modèle II. Supports en acier inoxydable (V4A) Gouttière - Aluminium anodise |
|---|--|---|

Poids - 10 kg/pièce

Dimensions du colis - 169x64x4 cm

Palletisation - 35 pièces / palette

Dimension de la palette - 171x64x160 cm
Poids de la palette + 35 auvents 370 kg brut

Inclus les vis et les chevilles pour le montage individuel.

LIGHTLINE ŚCIANKA XL

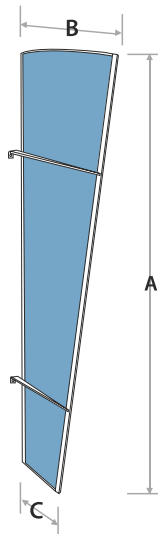

| Model | | | Wypełnienie | Indeks | Lp. |
|--------|--------|--------|-------------|--------|-----|
| A (cm) | B (cm) | C (cm) | | | |
| 167 | 85 | 55 | | 160945 | 157 |
| | | | | 160946 | 158 |
| | | | | 160947 | 159 |
| | | | | 160948 | 160 |
| 167 | 85 | 55 | | 170945 | 161 |
| | | | | 170946 | 162 |
| | | | | 170947 | 163 |
| | | | | 170948 | 164 |
| 167 | 85 | 55 | | 180945 | 165 |
| | | | | 180946 | 166 |
| | | | | 180947 | 167 |
| | | | | 180948 | 168 |

Wypełnienie ścianek - płyta akrylowa 6 mm.

przejrzysty

satyna biała

satyna niebieska

satyna zielona

Konstrukcja ścianek:

| | | |
|---|---|--|
| Model I. Uchwyty mocujące – stal czarna ocynkowana lakierowana proszkowo RAL9010 Profil aluminiowy lakierowany proszkowo RAL9010 | Model II. Uchwyty mocujące – stal nierdzewna (V2A) Profil aluminiowy anodowany | Model III. Uchwyty mocujące – stal kwasoodporna (V4A) Profil aluminiowy anodowany |
|---|---|--|

Waga ścianek - 13 kg / sztuka

Wymiar opakowania – 169x84x4cm

Paletowanie – 35 sztuk/paleta

Wymiar palety – 171x84x160 cm
 – Waga palety+35 ścianek 475 kg brutto

W komplecie śruby i kołki rozporowe do samodzielnego montażu daszka.



LIGHTLINE SIDE PANEL XL

Acrylic plate 6 mm.

transparent

satin white

satin blue

satin green

Construction of side panel:

| | | |
|--|---|---|
| <p>Model I. Supporting legs – galvanized steel black powder coated RAL9010 Powder coated aluminum profile RAL9010</p> | <p>Model II. Supporting legs – stainless steel (V2A) Anodized aluminum profile</p> | <p>Model III. Supporting legs – acid resistant steel (V4A) Anodized aluminum profile</p> |
|--|---|---|

Weight of side panel - 13 kg / pcs.

Size of packaging – 169x84x4 cm

Palletizing – 35 pcs./palette

Size of palette – 171x86x160 cm
– Weight of palette +35 side panels 475 kg brutto

Complete set for self assembly.



LIGHTLINE SEITENTEIL XL

Füllung – Acrylglas 6 mm.

klar

satiniert weiß

satiniert blau

satiniert gruen

Konstruktion:

| | | |
|--|---|---|
| <p>Modell I: Träger - Stahl Schwarz verzinkt, pulverbeschichtet RAL9010 Aluminiumprofil pulverbeschichtet RAL9010</p> | <p>Modell II: Träger – Edelstahl (V2A) Aluminiumprofil anodaized</p> | <p>Modell III: Träger – Stahl mit suäre Widerstandsfähigkeit (V4A) Aluminiumprofil anodaized</p> |
|--|---|---|

Gewicht - 13 kg

Abmessungen der Verpackung – 169x84x4 cm

Paletteneinheit 35 Stück

Abmessungen der Palette – 171x86x160 cm
Gewicht der Palette 475 kg brutto

Komplett mit Schrauben und Dübel zur Selbstmontage.



LIGHTLINE PAROI XL

Réalisation des auvents – plaque acrylique 6 mm.

Clair

Satiné Blanc

Satiné Bleu

Satiné Vert

Construction des auvents:

| | | |
|--|---|---|
| <p>Le modèle I. Supports – acier noir galvanisé, paint en pulvérisation RAL 9010 Goutière, profilé du près du mur – aluminium paint en pulvérisation RAL 9010</p> | <p>Le modèle II. Supports en acier inoxydable (V2A) Goutière, profilé du près du mur – aluminium anodisé</p> | <p>Le modèle III. Supports - Acier resistant aux acides (V4A) Profil d'aluminium anodise</p> |
|--|---|---|

Poids - 13 kg/pièce

Dimensions du colis - 169x84x4 cm





Palletisation - 35 pièces / palette

Dimension de la palette - 171x86x160 cm
Poids de la palette + 35 auvents 475 kg brut

Inclus les vis et les chevilles pour le montage individuel.

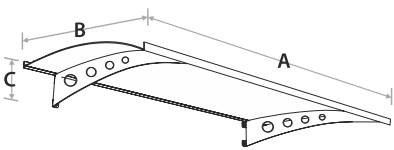
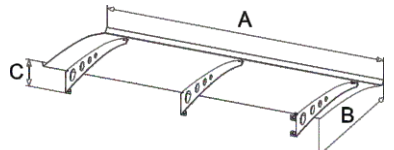
PICOTOP

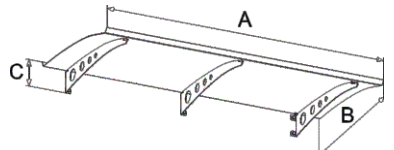

|  | Model | | | Wypełnienie | Indeks | Lp. |
|---|--------|--------|--------|--|--------|-----|
| | A (cm) | B (cm) | C (cm) | | | |
|  | 140 | 90 | 17 |  | 170650 | 169 |
|  | 180 | 90 | 17 |  | 170651 | 170 |



Wypełnienie daszków – płyta poliwęglan lity 3 mm.

przejrzysty

Konstrukcja daszków:

Nogi podporowe – stal czarna ocynkowana / lakierowana proszkowo RAL9007

Waga daszków:

10 kg / sztuka dla daszka 140x90 cm

16 kg / sztuka dla daszka 180x90 cm

Wymiar opakowania:

148x98x6 cm dla daszka 140x90 cm

188x98x6 cm dla daszka 180x90 cm

Paletowanie:

50 sztuk/paletadla daszka 140x90 cm

30 sztuk/paleta dla daszka 180x90 cm

Wymiar palety:

170650 150x100x170 cm dla daszka 140x90 cm

– Waga palety+50 daszków 520 kg brutto

170651 190x100x200 cm dla daszka 180x90 cm

– Waga palety+30 daszków 530 kg brutto

W komplecie śruby i kołki rozporowe do samodzielnego montażu daszka.



PICOTOP

Solid polycarbonate plate 3 mm.

transparent

Construction of conopies:

Supporting legs – galvanized steel black / powder coated RAL9007

Weight of conopies: 10 kg / pcs. for connopy 140x90 cm; 16 kg / pcs. for connopy 180x90 cm

Size of packaging: 148x98x6 cm for connopy 140x90 cm; 188x98x6 cm for connopy 180x90 cm

Palletizing: 50 pcs./palette for connopy 140x90 cm; 30 pcs./palette for connopy 180x90 cm

Size of palette:

170650 150x100x170 cm for connopy 140x90 cm
– Weight of palette +50 conopies 520 kg brutto

170651 190x100x200 cm for connopy 180x90 cm
– Weight of palette +30 conopies 530 kg brutto

Complete set for self assembly.



PICOTOP

Füllung – Polykarbonat Festplatte 3 mm.

klar

Konstruktion – Träger - Stahl Schwarz Verzinkt / pulverbeschichtet RAL9007

Gewicht: 10 kg für Vordäch 140x90cm; 16 kg für Vordäch 180x90cm

Abmessungen der Verpackung: 148x98x6cm für Vordäch 140x90cm; 148x98x6cm für Vordäch 180x90cm

Paletteneinheit: 50 Stück für Vordäch 140x90cm; 30 Stück für Vordäch 180x90cm

Abmessungen der Palette:

170650 150x100x170cm für Vordäch 140x90cm
Gewicht der Palette 520 kg brutto

170651 190x100x200cm für Vordäch 180x90cm
Gewicht der Palette 530 kg brutto

Komplett mit Schrauben und Dübel zur Selbstmontage.



PICOTOP

Réalisation des auvents – polycarbonat uni 3 mm.

Clair

Construction des auvents:

Supports – acier noir galvanisé, peint en pulvérisation RAL 9007

Poids: 10 kg/pièce pour un auvent 140x90 cm; 16 kg/pièce pour un auvent 180x90 cm

Dimensions du colis: 148x98x6 cm pour un auvent 140x90 cm; 188x98x6 cm pour un auvent 180x90 cm

Palletisation: 50 pièce / palette pour un auvent 140x90 cm; 30 pièce / palette pour un auvent 180x90 cm

Dimension de la palette:





170650 - 150x100x170 cm pour un auvent 140x90 cm
- Poids de la palette + 50 auvents 520 kg brut

170651 - 190x100x200 cm pour un auvent 180x90 cm
- Poids de la palette + 30 auvents 530 kg brut

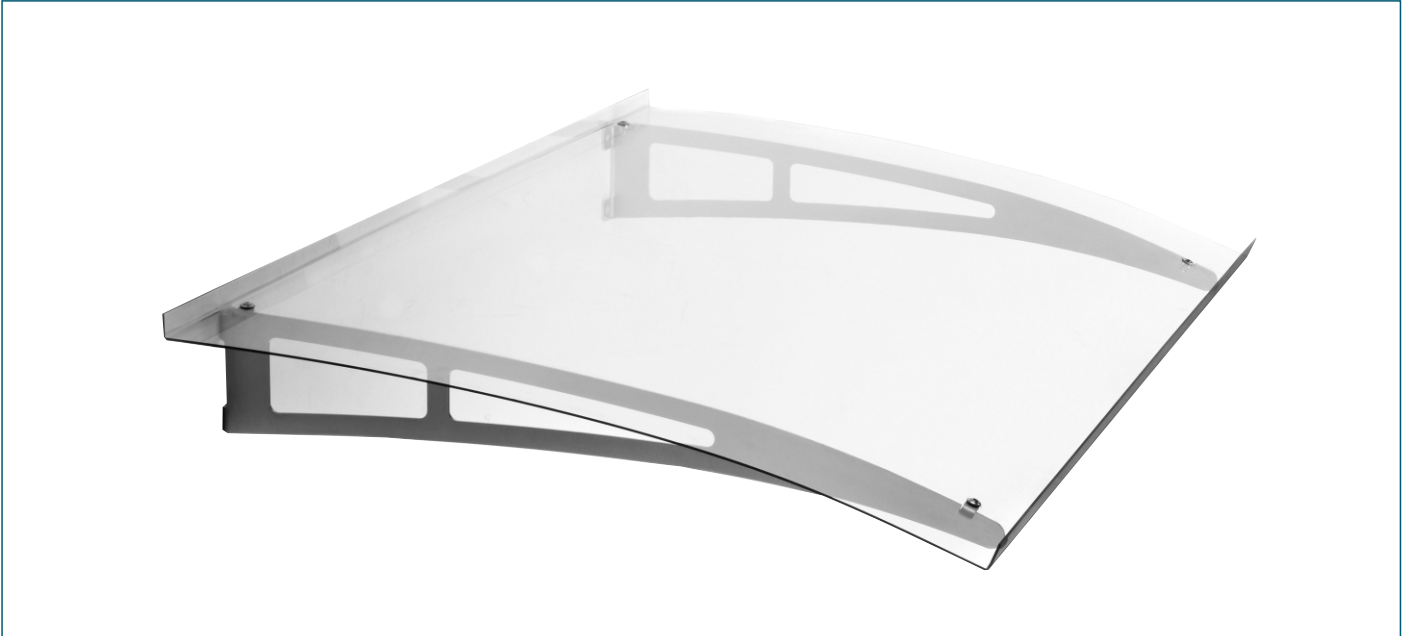
Inclus les vis et les chevilles pour le montage individuel.

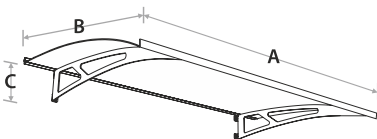
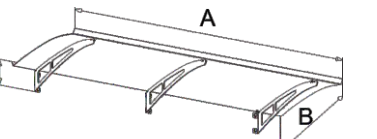
EASYTOP

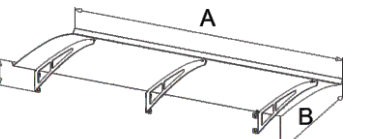

|  | Model | | | Wypełnienie | Indeks | Lp. |
|---|--------|--------|--------|--|--------|-----|
| | A (cm) | B (cm) | C (cm) | | | |
|  | 140 | 90 | 17 |  | 170640 | 171 |
|  | 180 | 90 | 17 |  | 170646 | 172 |

 **Wypełnienie daszków** – płyta poliwęglan lity 3mm.

 przejrzysty

Konstrukcja daszków:

Nogi podporowe – stal nierdzewna (V2A)

Waga daszków:

10 kg / sztuka dla daszka 140x90 cm
16 kg / sztuka dla daszka 180x90 cm

Wymiar opakowania:

– 148x98x6 cm dla daszka 140x90 cm
– 188x98x6 cm dla daszka 180x90 cm

Paletowanie:

– 30 sztuk/palet dla daszka 140x90 cm
– 30 sztuk/palet dla daszka 180x90 cm

Wymiar palety:

170640 – 150x100x200 cm dla daszka 140x90 cm
– Waga palety+30 daszków 320 kg brutto

170646 – 190x100x200 cm dla daszka 180x90 cm
– Waga palety+30 daszków 510 kg brutto

W komplecie śruby i kołki rozporowe do samodzielnego montażu daszka.



EASYTOP

Solid polycarbonate plate 3 mm.

transparent

Construction of conopies:

Supporting legs – stainless steel (V2A)

Weight of conopies: 10 kg / pcs. for conopy 140x90 cm; 16 kg / pcs. for conopy 180x90 cm

Size of packaging: 148x98x6 cm for conopy 140x90 cm; 188x98x6 cm for conopy 180x90 cm

Palletizing: 30 pcs./palette for conopy 140x90 cm; 30 pcs./palette for conopy 180x90 cm

Size of palette:

170640 150x100x200 cm for conopy 140x90 cm
– Weight of palette +30 conopies 320 kg brutto

170646 190x100x200 cm for conopy 180x90 cm
– Weight of palette +30 conopies 510 kg brutto

Complete set for self assembly.



EASYTOP

Füllung – Polykarbonat Festplate 3 mm.

klar

Konstruktion:

Träger – Edelstahl (V2A)

Gewicht: 10 kg für Vordäch 140x90cm; 16 kg für Vordäch 180x90cm

Abmessungen der Verpackung: 148x98x6cm für Vordäch 140x90cm; 188x98x6cm für Vordäch 180x90cm

Paletteneinheit: 50 Stück für Vordäch 140x90cm; 30 Stück für Vordäch 180x90cm

Abmessungen der Palette:

170640 150x100x200 cm für Vordäch 140x90cm
Gewicht der Palette 320 kg brutto

170646 190x100x200cm für Vordäch 180x90cm
Gewicht der Palette 510 kg brutto

Komplett mit Schrauben und Dübel zur Selbstmontage.



EASYTOP

Réalisation des auvents – polycarbonat uni 3 mm.

Clair

Construction des auvents:

Supports en acier inoxydable (V2A)

Poids: 10 kg/pièce pour un auvent 140x90 cm; 16 kg/pièce pour un auvent 180x90 cm

Dimensions du colis: 148x98x6 cm pour un auvent 140x90 cm; 188x98x6 cm pour un auvent 180x90 cm

Palletisation: 50 pièce / palette pour un auvent 140x90 cm; 30 pièce / palette pour un auvent 180x90 cm

Dimension de la palette:



170640 - 150x100x200 cm pour un auvent 140x90 cm
- Poids de la palette + 30 auvents 320 kg brut

170651 - 190x100x200 cm pour un auvent 180x90 cm
- Poids de la palette + 30 auvents 510 kg brut

Inclus les vis et les chevilles pour le montage individuel.

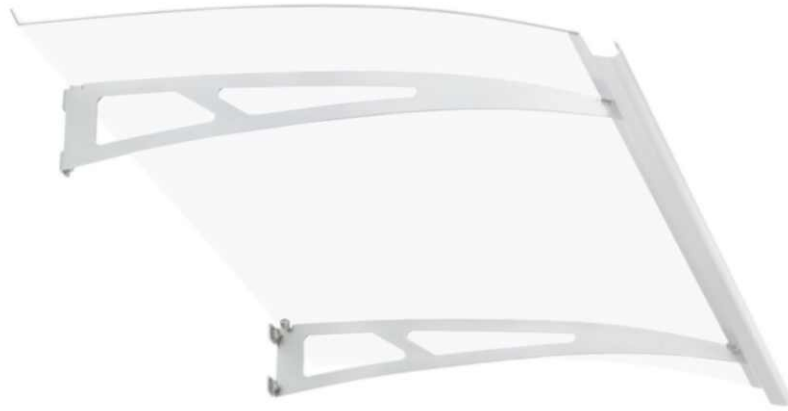
EXCLUSIVE LINE

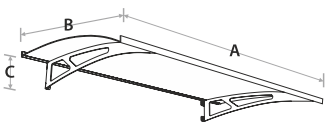
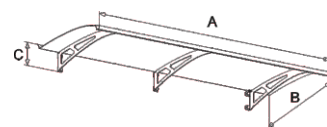

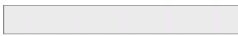
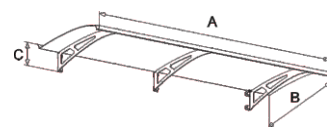
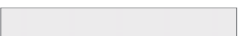
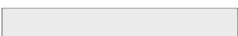
|  | Model | | | | Wypełnienie | Indeks | Lp. |
|---|--------|--------|--------|---------|---|--------|-----|
| | A (cm) | B (cm) | C (cm) | kolor | | | |
|  | 140 | 90 | 17 | RAL9010 |  | 170641 | 173 |
| | 140 | 90 | 17 | RAL9006 |  | 170643 | 174 |
|  | 180 | 90 | 17 | RAL9010 |  | 170642 | 175 |
| | 180 | 90 | 17 | RAL9006 |  | 170644 | 176 |



Wypełnienie daszków – płyta poliwęglan lity 3mm.

 przejrzysty

Konstrukcja daszków:

Nogi podporowe – stal czarna ocynkowana / lakierowana proszkowo RAL9010 lub RAL9006
 Profile aluminiowe - aluminium lakierowane proszkowo RAL9010 lub RAL9006

Waga daszków - 10 kg / sztuka dla daszka 140x90 cm
 - 16 kg / sztuka dla daszka 180x90 cm

Wymiar opakowania – 148x98x6 cm dla daszka 140x90 cm
 - 188x98x6 cm dla daszka 180x90 cm

Paletowanie – 30 sztuk/paletadla daszka 140x90 cm
 30 sztuk/paletadla daszka 180x90 cm

Wymiar palety:

170641 – 150x100x200 cm dla daszka 140x90 cm
 170643 – Waga palety+30 daszków 320 kg brutto
 170642 – 190x100x200 cm dla daszka 180x90 cm
 170644 – Waga palety+30 daszków 510 kg brutto

W komplecie śruby i kołki rozporowe do samodzielnego montażu daszka.



EXCLUSIVELINE

Solid polycarbonate plate 3 mm.

transparent

Construction of conopies:

Supporting legs – galvanized steel black / powder coated RAL9010 or RAL9006
Aluminium profile – aluminium powder coated RAL9010 or RAL9006

Weight of conopies: 10 kg / pcs. for conopy 140x90 cm; 16 kg / pcs. for conopy 180x90 cm

Size of packaging: 148x98x6 cm for conopy 140x90 cm; 188x98x6 cm for conopy 180x90 cm

Palletizing: 30 pcs./palette for conopy 140x90 cm; 30 pcs./palette for conopy 180x90 cm

Size of palette:

170641 150x100x200 cm for conopy 140x90 cm
170643 – Weight of palette +30 conopies 320 kg brutto

170642 190x100x200 cm for conopy 180x90 cm
170644 – Weight of palette +30 conopies 510 kg brutto

Complete set for self assembly.



EXCLUSIVELINE

Füllung – Polykarbonat Festplatte 3 mm.

klar

Konstruktion:

Träger - Stahl Schwarz Verzinkt, pulverbeschichtet RAL9010 lub RAL9006
Aluprofile - aluminium pulverbeschichtet RAL9010 lub RAL9006

Gewicht: 10 kg für Vordäch 140x90 cm; 16 kg für Vordäch 180x90 cm

Abmessungen der Verpackung: 148x98x6 cm für Vordäch 140x90 cm; 188x98x6 cm für Vordäch 180x90 cm

Paletteneinheit: 30 Stück für Vordäch 140x90 cm; 30 Stück für Vordäch 180x90 cm

Abmessungen der Palette:

170641 – 150x100x200 cm für Vordäch 140x90 cm
170643 – Gewicht der Palette 320 kg brutto

170642 – 190x100x200 cm für Vordäch 180x90 cm
170644 – Gewicht der Palette 510 kg brutto

Komplett mit Schrauben und Dübel zur Selbstmontage.



EXCLUSIVELINE

Réalisation des auvents – polycarbonat uni 3 mm.

Clair

Construction des auvents:

Supports – acier noir galvanisé, peint en pulverization RAL 9010 ou 9006
le profil en aluminium – aluminium peint en pulverisation RAL 9010 ou 9006

Poids: 10 kg/pièce pour un auvent 140x90 cm; 16 kg/pièce pour un auvent 180x90 cm

Dimensions du colis: 148x98x6 cm pour un auvent 140x90 cm; 188x98x6 cm pour un auvent 180x90 cm

Palletisation: 30 pièce / palette pour un auvent 140x90 cm; 30 pièce / palette pour un auvent 180x90 cm

Dimension de la palette:

170641 - 150x100x200 cm pour un auvent 140x90 cm
170643 - Poids de la palette + 30 auvents 320 kg brut

170642 - 190x100x200 cm pour un auvent 180x90 cm
170644 - Poids de la palette + 30 auvents 510 kg brut

Inclus les vis et les chevilles pour le montage individuel.

FLIPTOP

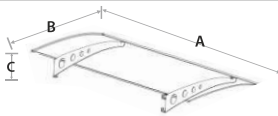
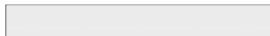

|  | Model | | | Wypełnienie | Indeks | Lp. |
|---|--------|--------|--------|-------------|--|--------|
| | A (cm) | B (cm) | C (cm) | | | |
| | | 140 | 90 | 17 |  | 170656 |

 **Wypełnienie daszków** – płyta poliwęglan komorowy 6 mm.



Konstrukcja daszków:

Nogi podporowe – stal czarna ocynkowana lakierowana proszkowo RAL9010

Profile aluminiowe - lakierowane proszkowo RAL9010

Waga daszków - 8 kg / sztuka

Wymiar opakowania – 148x98x6 cm

Paletowanie – 30 sztuk/paleta

Wymiar palety – 150x10x200 cm

– Waga palety+30 daszków 260 kg brutto

W komplecie śruby i kołki rozporowe do samodzielnego montażu daszka.



FLIPTOP

Multiwall polycarbonate plate 6 mm.

transparent

Construction of conopies:

Supporting legs – galvanized steel black powder coated RAL9010
Aluminium profile – aluminium powder coated RAL9010

Weight of conopies - 8 kg / pcs.

Size of packaging – 148x98x6 cm

Palletizing – 30 pcs./palette

Size of palette – 150x100x200 cm
– Weight of palette +30 conopies 260 kg brutto

Complete set for self assembly.



FLIPTOP

Füllung – Polykarbonat Kammerplate 6 mm.

klar

Konstruktion:

Träger - Stahl Schwarz Verzinkt, pulverbeschichtet RAL9010
Aluprofil - aluminium pulverbeschichtet RAL9010

Gewicht 8 kg

Abmessungen der Verpackung – 148x98x6 cm

Paletteneinheit 30 Stück

Abmessungen der Palette:

– 150x10x200 cm
Gewicht der Palette 260 kg brutto

Komplett mit Schrauben und Dübel zur Selbstmontage.



FLIPTOP

Réalisation des auvents – polycarbonate alvéolaire 6 mm.

Clair

Construction des auvents:

Supports – acier noir galvanisé, peint en pulvérisation RAL 9010
le profil en aluminium – aluminium peint en pulvérisation RAL 9010

Poids - 8 kg/pièce

Dimensions du colis - 148x98x6 cm

Palletisation - 30 pièces / palette

Dimension de la palette - 150x10x200 cm
Poids de la palette + 30 auvents 260 kg brut

Inclus les vis et les chevilles pour le montage individuel.

EUROTOP

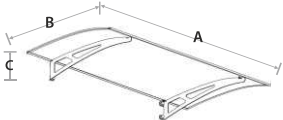
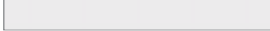

|  | Model | | | Wypełnienie | Indeks | Lp. |
|---|--------|--------|--------|-------------|--|--------|
| | A (cm) | B (cm) | C (cm) | | | |
| | | 140 | 90 | 17 |  | 170657 |

 **Wypełnienie daszków** – płyta poliwęglan komorowy 6 mm.



Konstrukcja daszków:

Nogi podporowe – stal czarna ocynkowana lakierowana proszkowo RAL9010

Profile aluminiowe - lakierowane proszkowo RAL9010

Waga daszków - 8 kg / sztuka

Wymiar opakowania – 148x98x6 cm

Paletowanie – 30 sztuk/paleta

Wymiar palety – 150x100x200 cm

– Waga palety+30 daszków 260 kg brutto

W komplecie śruby i kołki rozporowe do samodzielnego montażu daszka.



EUROTOP

Multiwall polycarbonate plate 4 mm.

transparent

Construction of conopies:

Supporting legs – galvanized steel black powder coated RAL9010
Aluminium profile – aluminium powder coated RAL9010

Weight of conopies - 8 kg / pcs.

Size of packaging – 148x98x6 cm

Palletizing – 30 pcs./palette

Size of palette – 150x100x200 cm
– Weight of palette +30 conopies 260 kg brutto

Complete set for self assembly.



EUROTOP

Füllung – Polykarbonat Kammerplate 6 mm.

klar

Konstruktion:

Träger - Stahl Schwarz Verzinkt, pulverbeschichtet RAL9010
Aluprofil - aluminium pulverbeschichtet RAL9010

Gewicht 8 kg

Abmessungen der Verpackung – 148x98x6 cm

Paletteneinheit 30 Stück

Abmessungen der Palette:

– 150x100x200 cm
Gewicht der Palette 260 kg brutto

Komplett mit Schrauben und Dübel zur Selbstmontage.



EUROTOP

Réalisation des auvents – polycarbonate alvéolaire 6 mm.

Clair

Construction des auvents:

Supports – acier noir galvanisé, peint en pulvérisation RAL 9010
le profil en aluminium – aluminium peint en pulvérisation RAL 9010

Poids - 8 kg/pièce

Dimensions du colis - 148x98x6 cm

Palletisation - 30 pièces / palette

Dimension de la palette - 150x100x200 cm
Poids de la palette + 30 auvents 260 kg brut

Inclus les vis et les chevilles pour le montage individuel.

EXTRA



| | Model | | | Wypełnienie | Indeks | Lp. |
|--|--------|--------|--------|-------------|--------|-------|
| | A (cm) | B (cm) | C (cm) | | | |
| | | 150 | 90 | 24 | | M1260 |

Wypełnienie daszków – płyta akrylowa 4 mm.

przejrzysty

Konstrukcja daszków:

Aluminium lakierowane proszkowo RAL9006

Waga daszków - 12,8 kg / sztuka

Wymiar opakowania – 155x95x13 cm

Paletowanie – 15 sztuk/paleta

Wymiar palety – 157x97x215 cm

– Waga palety+15 daszków 210 kg brutto

W komplecie śruby i kołki rozporowe do samodzielnego montażu daszka.



EXTRA

Acryl plate 4 mm.

transparent

Construction of conopies:

Aluminium powder coated RAL9006

Weight of conopies - 12,8 kg / pcs.

Size of packaging – 155x95x13 cm

Palletizing – 15 pcs./palette

Size of palette – 157x97x215 cm

– Weight of palette +15 conopies 210 kg brutto

Complete set for self assembly.



EXTRA

Füllung – Acrylglas 4 mm.

klar

Konstruktion:

Aluminium pulverbeschichtet RAL9006

Gewicht 12,8 kg

Abmessungen der Verpackung – 155x95x13 cm

Paletteneinheit 15 Stück

Abmessungen der Palette – 157x97x215 cm

Gewicht der Palette 210 kg brutto

Komplett mit Schrauben und Dübel zur Selbstmontage.



EXTRA

Réalisation des auvents – plaque acrylique 4mm.

Clair

Construction des auvents:

Aluminium peint en pulvérisation RAL 9006

Poids - 12,8 kg/pièce

Dimensions du colis - 155x95x13 cm

Palletisation - 15 pièces / palette

Dimension de la palette - 157x97x215 cm

Poids de la palette + 15 auvents 210 kg brut

Inclus les vis et les chevilles pour le montage individuel.

SMART



| | Model | | | Wypełnienie | Indeks | Lp. |
|--|--------|--------|--------|-------------|--------|-----|
| | A (cm) | B (cm) | C (cm) | | | |
| | 140 | 90 | 27 | | M1270 | 180 |



Wypełnienie daszków – płyta poliwęglan lity 3mm.

przejrzysty

Konstrukcja daszków:

Aluminium lakierowane proszkowo RAL9006

Waga daszków - 9 kg / sztuka

Wymiar opakowania – 145x95x13 cm

Paletowanie – 15 sztuk/paleta

Wymiar palety – 147x97x215 cm

– Waga palety+15 daszków 150 kg brutto

W komplecie śruby i kołki rozporowe do samodzielnego montażu daszka.



SMART

Solid polycarbonate plate 3 mm.

transparent

Construction of conopies:

Aluminium powder coated RAL9006

Weight of conopies - 9 kg/pcs.

Size of packaging - 145x95x13 cm

Palletizing - 15 pcs./palette

Size of palette - 147x97x215 cm

- Weight of palette +15 conopies 150 kg brutto

Complete set for self assembly.



SMART

Füllung - Polykarbonat Festplatte 3 mm.

klar

Konstruktion:

Aluminium pulverbeschichtet RAL9006

Gewicht 9 kg

Abmessungen der Verpackung - 145x95x13 cm

Paletteneinheit 15 Stück

Abmessungen der Palette - 147x97x215 cm

Gewicht der Palette 150 kg brutto

Komplett mit Schrauben und Dübel zur Selbstmontage.



SMART

Réalisation des auvents - polycarbonat uni 3 mm.

Clair

Construction des auvents:

Aluminium paint en pulvérisation RAL 9006

Poids - 9 kg/pièce

Dimensions du colis - 145x95x13 cm

Palletisation - 15 pièces / palette

Dimension de la palette - 147x97x215 cm

Poids de la palette +15 auvents 150 kg brut

Inclus les vis et les chevilles pour le montage individuel.

DASZEK SZKLANY

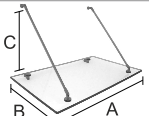
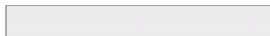

|  | Model | | | Wypełnienie | Indeks | Lp. |
|---|--------|--------|--------|--|--------|-----|
| | A (cm) | B (cm) | C (cm) | | | |
| | 140 | 90 | 27 |  | M1280 | 181 |

Wypełnienie daszków:

 przejrzysty

– Szkło hartowane 2x5 mm.

Konstrukcja daszków:

Podpory i odciągi – stal nierdzewna V2A

Waga daszków:

– 40 kg / sztuka

Wymiar opakowania:

– 150x100x10 cm

Paletowanie:

– 15 sztuk

Wymiar palety:

– 153x103x170 cm

– Waga palety + 15 daszków 640 kg brutto

W komplecie śruby i kołki rozporowe do samodzielnego montażu daszka.



CONNOPY WITH FILLING MADE FROM GLASS

Tempered glass 2x5 mm.

transparent

Construction of conopies:

Supports and lifts - stainless steel

Weight of conopies - 40 kg/pcs.

Size of packaging – 150x100x10 cm

Palletizing – 15 pcs./palette

Size of palette – 153x103x170 cm

– Weight of palette +15 conopies 640 kg brutto

Complete set for self assembly.



VORDACH MIT GLASÜBERDECKUNG

Füllung – gehärtetem Glas 2x5 mm.

klar

Konstruktion:

Träger und Auspuff - Edelstahl

Gewicht 40 kg

Abmessungen der Verpackung – 150x100x10 cm

Paletteneinheit 15 Stück

Abmessungen der Palette – 153x103x170 cm

Gewicht der Palette 640 kg brutto

Komplett mit Schrauben und Dübel zur Selbstmontage.



MARQUISE EN VERRE

Réalisation des auvents – verre trempé 2x5 mm

Clair

Construction des auvents:

Les supports et linteaux - acier inoxydable

Poids - 40 kg/pièce

Dimensions du colis - 150x100x10 cm

Palletisation - 15 pièces / palette



Dimension de la palette - 153x103x170 cm

Poids de la palette + 15 auvents 640 kg brut

Inclus les vis et les chevilles pour le montage individuel.

LIGHTLINE L1500

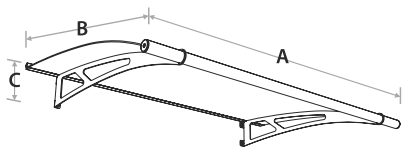

|  Model II. | Model | | | Wypełnienie | Indeks | Lp. |
|---|---------------|---------------|---------------|---|---------------|------------|
| | A (cm) | B (cm) | C (cm) | | | |
| | 150 | 95 | 17 |  | 190900 | 182 |

 **Wypełnienie daszków** - poliwęglan komorowy 4 mm.

przejrzysty

Konstrukcja daszków:

Nogi podporowe – stal czarna ocynkowana lakierowana proszkowo RAL7024
 Rynna, profil przyścienny – aluminium
 lakierowane proszkowo RAL7024

Waga daszków - 16 kg / sztuka

Wymiar opakowania – 152x95x8cm

Paletowanie – 30 sztuk/paleta

Wymiar palety – 154x97x260 cm

– Waga palety+30 daszków 500 kg brutto

W komplecie śruby i kołki rozporowe do samodzielnego montażu daszka.



LIGHTLINE L1500

Multiwall polycarbonate plate 4 mm.

transparent

Construction of conopies:

Supporting legs – galvanized steel black powder coated RAL7024
Gutter, wall profile – galvanized aluminum powder coated RAL7024

Weight of conopies - 16 kg / pcs.

Size of packaging – 152x95x8 cm

Palletizing – 30 pcs./palette

Size of palette – 154x97x260 cm
– Weight of palette +30 conopies 500 kg brutto

Complete set for self assembly.



LIGHTLINE L1500

Füllung – Polykarbonat Kammerplate 4mm.

klar

Konstruktion:

Träger - Stahl Schwarz verzinkt, pulverbeschichtet RAL7024
Regenrinne, Wandprofil - Aluminium pulverbeschichtet RAL7024

Gewicht - 16 kg

Abmessungen der Verpackung – 152x95x8cm

Paletteneinheit 30 Stück

Abmessungen der Palette – 154x97x260cm
Gewicht der Palette 500 kg brutto

Komplett mit Schrauben und Dübel zur Selbstmontage.



LIGHTLINE L1500

Réalisation des auvents – polycarbonate alvéolaire 4 mm.

Clair

Construction des auvents:

Supports – acier noir galvanisé, peint en pulvérisation RAL7024
Gouttière, profilé du près du mur – aluminium peint en pulvérisation RAL7024

Poids -16 kg/pièce

Dimensions du colis - 152x95x8 cm







Palletisation - 30 pièces / palette

Dimension de la palette - 154x97x260 cm
Poids de la palette + 30 auvents 500 kg brut

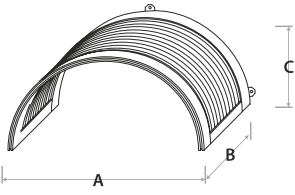
Inclus les vis et les chevilles pour le montage individuel.

DASZEK ŁUKOWY



|  | Wymiary | | | Wypełnienie | Kolor profili | Indeks | Lp. |
|--|---------|--------|--------|--|----------------|---------|-----|
| | A (cm) | B (cm) | C (cm) | | | | |
| | 158 | 75 | 38 |  | Biały RAL9016 | M0220 | 183 |
| | 158 | 75 | 38 |  | Brąz RAL8017 | M0300 | 184 |
| | 158 | 75 | 38 |  | Grafit RAL7024 | M0300G | 185 |
| | 158 | 90 | 38 |  | Biały RAL9016 | 170660 | 186 |
| | 158 | 90 | 38 |  | Brąz RAL8017 | 170661 | 187 |
| | 158 | 90 | 38 |  | Grafit RAL7024 | 170661G | 188 |



Wypełnienie daszków - płyta poliwęglan komorowy 4,5 mm (przejrzysty lub brązowy).

przejrzysty

brązowe

Konstrukcja daszków:

Aluminium lakierowane proszkowo

Waga daszków – 9,2 kg / sztuka dla daszka 158x75x38 cm
– 10 kg / sztuka dla daszka 158x90x38 cm

Wymiar opakowania – 175x70x8 cm dla daszka 158x75x38 cm
– 175x86x8 cm dla daszka 158x90x38 cm

Paletowanie – 30 sztuk/paleta

Wymiar palety:

– 177x72x260 cm dla daszka 158x75x38 cm (M0220; M0300; M0300G)
– Waga palety+30 daszków 300 kg brutto

– 177x88x260 cm dla daszka 158x90x38 cm (170660; 170661; 170661G)
– Waga palety+30 daszków 320 kg brutto

W komplecie śruby i kołki rozporowe do samodzielnego montażu daszka.



ARCHED SHED ROOF

Multiwall polycarbonate plate 4,5 mm (transparent or brown).

transparent

brown

Construction of canopies: Aluminium powder coated

Weight of canopies: 9,2 kg / pcs. for canopy 158x75x38 cm; 10 kg / pcs. for canopy 158x90x38 cm

Size of packaging – 175x70x8 cm for canopy 158x75x38 cm
– 175x86x8 cm for canopy 158x90x38 cm

Palletizing – 30 pcs./palette

Size of palette:

- 177x72x260 cm for canopy 158x75x38 cm (M0220; M0300; M0300G)
- Weight of palette +30 canopies 300 kg brutto
- 177x88x260 cm for canopy 158x90x38 cm (170660; 170661; 170661G)
- Weight of palette +30 canopies 320 kg brutto

Complete set for self assembly.



RUNDBOGENVORDACH

Füllung – Polykarbonat Kammerplatte 4,5 mm (klar oder braun).

klar

braun

Konstruktion: Aluminium pulverbeschichtet

Gewicht 9,2 kg für Vordäch 158x75x38 cm; 16 kg für Vordäch 158x90x38 cm

Abmessungen der Verpackung – 175x70x8 cm für Vordäch 158x75x38 cm
– 175x86x8 cm für Vordäch 158x90x38 cm

Paletteneinheit 30 Stück

Abmessungen der Palette:

- 177x72x260 cm für Vordäch 158x75x38 cm (M0220; M0300; M0300G)
- Gewicht der Palette 300 kg brutto
- 177x88x260 cm für Vordäch 158x90x38 cm (9170660; 170661; 170661G)
- Gewicht der Palette 320 kg brutto

Komplett mit Schrauben und Dübel zur Selbstmontage.



AUVENT VOÛTÉ

Réalisation des auvents – polycarbonat alvéolaire 4,5mm

clair

fumé

Construction des auvents: Aluminium paint en pulvérisation

Poids 9,2 kg/pièce pour un auvent 158x75x38 cm; 10 kg/pièce pour un auvent 158x90x38 cm

Dimensions du colis - 175x70x8 cm pour un auvent 158x75x38 cm
- 175x86x8 cm pour un auvent 158x90x38 cm

Palletisation - 30 pièce / palette

Dimension de la palette:

- 177x72x260 cm pour un auvent 158x75x38 cm (M0220; M0300; M0300G)
- Poids de la palette + 30 auvents 300 kg brut
- 177x88x260 cm pour un auvent 158x90x38 cm (170660; 170661; 170661G)
- Poids de la palette + 30 auvents 320 kg brut

Inclus les vis et les chevilles pour le montage individuel.

ŚCIANKA DO DASZKA ŁUKOWEGO



| | Wymiary | | | | Wypełnienie | Kolor profili | Indeks | Lp. |
|--|---------|--------|--------|---------------|-------------|----------------|---------|-----|
| | A (cm) | B (cm) | C (cm) | do głębokości | | | | |
| | 180 | 53 | 30 | 75 | | Biały RAL9016 | M0310 | 189 |
| | 180 | 53 | 30 | 75 | | Brąz RAL8017 | M0320 | 190 |
| | 180 | 53 | 30 | 75 | | Grafit RAL7024 | 170662G | 191 |
| | 180 | 53 | 30 | 90 | | Biały RAL9016 | 170662 | 192 |
| | 180 | 53 | 30 | 90 | | Brąz RAL8017 | 170663 | 193 |
| | 180 | 53 | 30 | 90 | | Grafit RAL7024 | M0310G | 194 |
| | 130 | 53 | 30 | 75 | | Biały RAL9016 | M0210 | 195 |
| | 130 | 53 | 30 | 75 | | Brąz RAL8017 | M0290 | 196 |
| | 130 | 53 | 30 | 75 | | Grafit RAL7024 | M0210G | 197 |

Wypełnienie ścianek – płyta poliwęglan komorowy 4,5 mm (przejrzysty lub brązowy).

przejrzysty

brązowe

Konstrukcja ścianek:

Aluminium lakierowane proszkowo

Waga ścianek – 10 kg / sztuka dla ścianki 180x53x30 cm

– 6 kg / sztuka dla ścianki 130x53x30 cm

Wymiar opakowania – 184x55x3 cm dla ścianki 180x53x30 cm

– 130x55x3 cm dla ścianki 130x53x30 cm

Paletowanie – 50 sztuk/paleta

Wymiar palety – 186x57x170 cm dla ścianki 180x53x30 cm (M0310; M0320; 170662; 170668)

– Waga palety+50 ścianek 520 kg brutto

– 132x53x170 cm dla ścianki 130x53x30 cm (M0210; M0290; M0310G; 170662G)

– Waga palety+50 ścianek 320 kg brutto

W komplecie śruby i kołki rozporowe do samodzielnego montażu daszka.



SIDE PANEL FOR ARCHED SHED ROOF

Multiwall polycarbonate plate 4,5 mm (transparent or brown).

transparent

brown

Construction of side panel: Aluminium powder coated

Weight of side panel – 10 kg / pcs. for connopy 180x53x30 cm
– 6 kg / pcs. for connopy 130x53x30 cm

Size of packaging – 184x55x3 cm for side panel 180x53x30 cm
– 130x55x3 cm for side panel 130x53x30 cm

Palletizing – 50 pcs./palette

Size of palette – 186x57x170 cm for side panel 180x53x30 cm (M0310; M0320; 170662; 170668)
– Weight of palette +50 side panels 520 kg brutto

– 132x57x170 cm for side panel 130x53x30 cm (M0210; M0290; M0310G; 170662G)
– Weight of palette +50 side panels 320 kg brutto

Complete set for self assembly.



SEITENTEIL FÜR RUNDBOGENVORDACH

Füllung – Polykarbonat Kammerplatte 4,5 mm (klar oder braun).

klar

braun

Konstruktion: Aluminium pulverbeschichtet

Gewicht – 10 kg für Seitenteil 180x53x30 cm
– 6 kg für Seitenteil 130x53x30 cm

Abmessungen der Verpackung – 184x55x3 cm für Seitenteil 180x53x30 cm
– 130x55x3 cm für Seitenteil 130x53x30 cm

Paletteneinheit 50 Stück

Abmessungen der Palette:

– 186x57x170 cm für Seitenteil 186x53x30 cm (M0310; M0320; 170662; 170668)
– Gewicht der Palette 520 kg brutto

– 132x5x170 cm für Vordäch 130x53x30 cm (M0210; M0290; M0310G; 170662G)
– Gewicht der Palette 320 kg brutto

Komplett mit Schrauben und Dübel zur Selbstmontage.



PAROI POUR AUVENT VOÛTÉ

Réalisation des auvents – polycarbonat alvéolaire 4,5mm

clair

fumé

Construction des auvents: Aluminium paint en pulvérisation

Poids – 10 kg/pièce pour un auvent 180x53x30 cm
– 6 kg/pièce pour un auvent 130x53x30 cm

Dimensions du colis – 184x55x3 cm pour un auvent 180x53x30 cm
– 130x55x3 cm pour un auvent 130x53x30 cm

Palletisation – 50 pièce / palette

Dimension de la palette:





– 186x57x170 cm pour un auvent 180x53x30 cm (M0310; M0320; 170662; 170668)
– Poids de la palette + 50 auvents 520 kg brut

– 132x53x170 cm pour un auvent 130x53x30 cm (M0210; M0290; M0310G; 170662G)
– Poids de la palette + 50 auvents 320 kg brut

Inclus les vis et les chevilles pour le montage individuel.

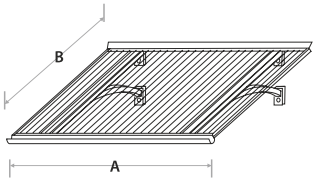
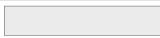
DASZEK PŁASKI Z POLIWĘGLANU KOMOROWEGO

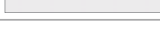

|  | Wymiary | | | Wypełnienie | Kolor profili | Indeks | Lp. |
|--|---------|--------|--------|--|----------------|--------|-----|
| | A (cm) | B (cm) | C (cm) | | | | |
| | 120 | 90 | 38 |  | Biały RAL9016 | 170760 | 199 |
| | 120 | 90 | 38 |  | Brąz RAL8017 | 170761 | 200 |
| | 120 | 90 | 38 |  | Grafit RAL7024 | M0621G | 201 |
| | 160 | 90 | 38 |  | Biały RAL9016 | 170860 | 202 |
| | 160 | 90 | 38 |  | Brąz RAL8017 | 170861 | 203 |
| | 160 | 90 | 38 |  | Grafit RAL7024 | M0641G | 204 |

 **Wypełnienie daszków** – płyta poliwęglan komorowy 4,5 mm (przejrzysta lub dymna).

 przejrzysty

 brązowe

Konstrukcja daszków:

Aluminium lakierowane proszkowo

Waga daszków – 6 kg / sztuka dla daszka 120x90 cm

– 8 kg / sztuka dla daszka 160x90 cm

Wymiar opakowania – 123x94x6 cm dla daszka 120x90 cm

– 163x94x6 cm dla daszka 160x90 cm

Paletowanie – 35 sztuk/paleta

Wymiar palety – 125x96x230 cm dla daszka 120x90 cm (170760; 170761; M0621G)

– Waga palety+35 daszków 225 kg brutto

165x96x230 cm dla daszka 160x90 cm (170860; 170861; M0641G)

– Waga palety+35 daszków 300 kg brutto

W komplecie śruby i kołki rozporowe do samodzielnego montażu daszka.



FLAT CONNOPY

Multiwall polycarbonate plate 4,5 mm (transparent or brown).

transparent

brown

Construction of conopies: Aluminium powder coated

Weight of conopies – 6 kg / pcs. for conopy 120x90 cm
– 8 kg / pcs. for conopy 160x90 cm

Size of packaging – 123x94x6 cm for conopy 120x90 cm
– 163x94x6 cm for conopy 160x90 cm

Palletizing – 35 pcs./palette

Size of palette – 125x96x230 cm for conopy 120x90 cm (170760; 170761; M0621G)
– Weight of palette +35 conopies 225 kg brutto

– 165x96x230 cm for conopy 160x90 cm (170860; 170861; M0641G)
– Weight of palette +50 conopies 300 kg brutto

Complete set for self assembly.



PLUTVORDACH

Füllung – Polykarbonat Kammerplatte 4,5 mm (klar oder braun).

klar

braun

Konstruktion: Aluminium pulverbeschichtet

Gewicht – 6 kg für Vordäch 120x90 cm
– 8 kg für Vordäch 160x90 cm

Abmessungen der Verpackung – 123x94x6 cm für Vordäch 120x90 cm
– 163x94x6 cm für Vordäch 160x90 cm

Paletteneinheit 35 Stück

Abmessungen der Palette:

– 125x96x230 cm für Vordäch 120x90 cm (170760; 170761; M0621G)
– Gewicht der Palette 225 kg brutto

– 165x96x230 cm für Vordäch 160x90 cm (170860; 170861; M0641G)
– Gewicht der Palette 300 kg brutto

Komplett mit Schrauben und Dübel zur Selbstmontage.



AUVENT PLONGEANT

Réalisation des auvents – polycarbonat alvéolaire 4,5mm

clair

fumé

Construction des auvents: Aluminium peint en pulvérisation

Poids - 6 kg/pièce pour un auvent 120x90 cm
- 8 kg/pièce pour un auvent 160x90 cm

Dimensions du colis - 123x94x6 cm pour un auvent 120x90 cm
- 163x94x6 cm pour un auvent 160x90 cm

Palletisation - 35 pièce / palette

Dimension de la palette:

- 125x96x230 cm pour un auvent 120x90 cm (170760; 170761; M0621G)
- Poids de la palette + 35 auvents 225 kg brut

- 165x96x230 cm pour un auvent 160x90 cm (170860; 170861; M0641G)
- Poids de la palette + 35 auvents 300 kg brut

Inclus les vis et les chevilles pour le montage individuel.

ŚCIANKA DO DASZKA PŁASKKIEGO

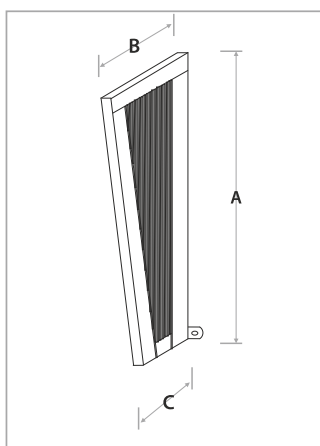

| Wymiary | | | Wypełnienie | Kolor profili | Indeks | Lp. |
|---------|--------|--------|-------------|----------------|--------|-----|
| A (cm) | B (cm) | C (cm) | | | | |
| 180 | 53 | 30 | | Biały RAL9016 | 170762 | 205 |
| 180 | 53 | 30 | | Brąz RAL8017 | 170763 | 206 |
| 180 | 53 | 30 | | Grafit RAL7024 | M0672G | 207 |

Wypełnienie ścianek – płyta poliwęglan komorowy 4,5 mm (przejrzysta lub dymna).

przejrzysty

brązowe

Konstrukcja ścianek:

Aluminium lakierowane proszkowo

Waga ścianek - 10 kg / sztuka

Wymiar opakowania – 184x55x3 cm

Paletowanie – 50 sztuk/paleta

Wymiar palety – 186x57x165 cm (170762; 170763; M0672G)

– Waga palety+50 ścianek 520 kg brutto

W komplecie śruby i kołki rozporowe do samodzielnego montażu daszka.



SIDE PANEL FOR FLAT CONNOPY

Multiwall polycarbonate plate 4,5 mm (transparent or brown).

transparent

brown

Construction of side panel:

Aluminium powder coated

Weight of side panel – 10 kg / pcs.

Size of packaging – 184x55x3 cm

Palletizing – 50 pcs./palette

Size of palette – 186x57x170 cm (170762; 170763; M0672G)

– Weight of palette +50 side panels 520 kg brutto

Complete set for self assembly.



SEITENTEIL FÜR PLUVORDACH

Füllung – Polykarbonat Kammerplatte 4,5 mm (klar oder braun).

klar

braun

Konstruktion:

Aluminium pulverbeschichtet

Gewicht 10 kg

Abmessungen der Verpackung – 184x55x3 cm

Paletteneinheit 50 Stück

Abmessungen der Palette – 186x57x170 cm

Gewicht der Palette 520 kg brutto

Komplett mit Schrauben und Dübel zur Selbstmontage.



PAROI POUR AUVENT PLONGEANT

Réalisation des auvents – polycarbonat alvéolaire 4,5mm

clair

fumé

Construction des auvents:

Aluminium paint en pulverisation

Poids - 10 kg/pièce

Dimensions du colis - 184x55x3 cm

Palletisation - 50 pièce / palette

Dimension de la palette:

- 186x57x170 cm pour un auvent 180x53x30 cm cm (170762; 170763; M0672G)

- Poids de la palette + 50 auvents 520 kg brut

Inclus les vis et les chevilles pour le montage individuel.

DASZEK ŁUKOWY „EKO”



| | Wymiary | | | Wypełnienie | Kolor profili | Indeks | Lp. |
|--|---------|--------|--------|-------------|----------------|--------|-----|
| | A (cm) | B (cm) | C (cm) | | | | |
| | 158 | 90 | 26 | | Biały RAL9016 | M0842 | 208 |
| | 158 | 90 | 26 | | Brąz RAL8017 | M0843 | 209 |
| | 158 | 90 | 26 | | Grafit RAL7024 | M0843G | 210 |

Wypełnienie daszków – płyta poliwęglan komorowy 4,5 mm.

przejrzysty

brązowe

Konstrukcja daszków:

Aluminium lakierowane proszkowo

Waga daszków - 10 kg / sztuka

Wymiar opakowania – 163x94x6 cm

Paletowanie – 35 sztuk/paleta

Wymiar palety – 165x96x230 cm

– Waga palety+35 daszków 370 kg brutto

W komplecie śruby i kołki rozporowe do samodzielnego montażu daszka.



ARCHED SHED CONNOPY „EKO”

Multiwall polycarbonate plate 4,5 mm.

transparent

brown

Construction of conopies:

Aluminium powder coated

Weight of conopies – 10 kg / pcs.

Size of packaging – 163x94x6 cm

Palletizing – 35 pcs./palette

Size of palette – 165x96x225 cm

– Weight of palette +35 conopies 370 kg brutto

Complete set for self assembly



RUNDBOGENVORDACH „EKO”

Füllung – Polykarbonat Kammerplate 4,5 mm (klar oder braun).

klar

braun

Konstruktion:

Aluminium pulverbeschichtet

Gewicht 10 kg

Abmessungen der Verpackung – 163x94x6 cm

Paletteneinheit 35 Stück

Abmessungen der Palette – 165x96x230 cm

Gewicht der Palette 370 kg brutto

Komplett mit Schrauben und Dübel zur Selbstmontage.



AUVENT VOÛTÉ “ECO”

Réalisation des auvents – polycarbonat alvéolaire 4,5mm

clair

fumé

Construction des auvents:

Aluminium paint en pulverisation

Poids - 10 kg/pièce

Dimensions du colis - 163x94x6 cm

Palletisation - 35 pièce / palette

Dimension de la palette:

- 165x96x230 cm

- Poids de la palette + 35 auvents 370 kg brut

Inclus les vis et les chevilles pour le montage individuel.

DASZEK ŁUKOWY Z AKRYLU



|  | Wymiary | | | Wypełnienie | Kolor profili | Indeks | Lp. |
|--|---------|--------|--------|---|-----------------|---------|-----|
| | A (cm) | B (cm) | C (cm) | | | | |
| | 158 | 90 | 26 |  | Biały RAL9016 | 170970 | 211 |
| | 158 | 90 | 26 |  | Brąz RAL8017 | 170971 | 212 |
| | 158 | 90 | 26 |  | Srebrny RAL9006 | 170972 | 213 |
| | 158 | 90 | 26 |  | Grafit RAL7024 | 170970G | 214 |

 **Wypełnienie daszków** – płyta akrylowa przezroczysta 4 mm.

przezroczysty

brązowe

Konstrukcja daszków:

Aluminium lakierowane proszkowo

Waga daszków - 15 kg / sztuka

Wymiar opakowania – 163x94x6 cm

Paletowanie – 35 sztuk/paleta

Wymiar palety – 165x96x230 cm

– Waga palety+35 daszków 550 kg brutto

W komplecie śruby i kołki rozporowe do samodzielnego montażu daszka.



ARCHED SHED CONNOPIY

Transparent acryl plate 4 mm.

transparent

brown

Construction of conopies:

Aluminium powder coated

Weight of conopies – 15 kg / pcs.

Size of packaging – 163x94x6 cm

Palletizing – 35 pcs./palette

Size of palette – 165x96x230 cm
– Weight of palette +35 conopies 550 kg brutto

Complete set for self assembly.



RUNDBOGENVORDACH

Füllung – Acrylglas 4 mm.

klar

braun

Konstruktion:

Aluminium pulverbeschichtet

Gewicht 15 kg

Abmessungen der Verpackung – 163x94x6 cm

Paletteneinheit 35 Stück

Abmessungen der Palette – 165x96x230 cm
Gewicht der Palette 550 kg brutto

Komplett mit Schrauben und Dübel zur Selbstmontage.



AUVENT VOÛTÉ AVEC LE PLAQUE ACRYLIQUE

Réalisation des auvents – plaque acrylique claire 4mm.

clair

fumé

Construction des auvents:

Aluminium paint en pulverisation

Poids - 15 kg/pièce

Dimensions du colise - 163x94x6 cm

Palletisation - 35 pièce / palette





Dimension de la palette:

- 165x96x230 cm
- Poids de la palette + 35 auvents 550 kg brut

Inclus les vis et les chevilles pour le montage individuel.

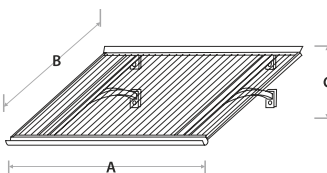
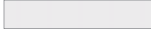
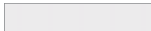
DASZEK PŁASKI Z AKRYLU

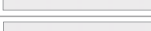
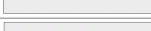
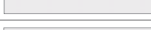

|  | Wymiary | | | Wypełnienie | Kolor profili | Indeks | Lp. |
|--|---------|--------|--------|---|-----------------|--------|-----|
| | A (cm) | B (cm) | C (cm) | | | | |
| | 120 | 90 | 38 |  | Biały RAL9016 | 170950 | 215 |
| | 120 | 90 | 38 |  | Brąz RAL8017 | 170951 | 216 |
| | 120 | 90 | 38 |  | Srebrny RAL9006 | 170952 | 217 |
| | 120 | 90 | 38 |  | Grafit RAL7024 | M0891G | 218 |
| | 160 | 90 | 38 |  | Brąz RAL8017 | 170956 | 219 |
| | 160 | 90 | 38 |  | Srebrny RAL9006 | 170957 | 220 |
| | 160 | 90 | 38 |  | Biały RAL9016 | 170955 | 221 |
| | 160 | 90 | 38 |  | Grafit RAL7024 | M0921G | 222 |

 **Wypełnienie daszków** – płyta akrylowa przejrzysta 4 mm.

 przejrzysty

Konstrukcja daszków:

Aluminium lakierowane proszkowo

Waga daszków – 11 kg / sztuka dla daszka 120x90 cm

– 14 kg / sztuka dla daszka 160x90 cm

Wymiar opakowania – 123x94x6 cm dla daszka 120x90 cm

– 163x94x6 cm dla daszka 160x90 cm

Paletowanie – 35 sztuk/paleta

Wymiar palety – 115x96x230 cm dla daszka 120x90 cm (170950; 170951; 170952; M0891G)

– Waga palety+35 daszków 400 kg brutto

– 165x96x230 cm dla daszka 160x90 cm (170955; 170956; 170957; M0921G)

– Waga palety+35 daszków 520 kg brutto

W komplecie śruby i kołki rozporowe do samodzielnego montażu daszka.



FLAT CONNOPY

Transparent acryl plate 4 mm.

transparent

Construction of conopies: Aluminium powder coated

Weight of conopies – 11 kg / pcs. for conopy 120x90 cm
– 16 kg / pcs. for conopy 160x90 cm

Size of packaging – 123x94x6 cm for conopy 120x90 cm
– 163x94x6 cm for conopy 160x90 cm

Palletizing – 35 pcs./palette

Size of palette – 115x96x230 cm for connopy 120x90 cm (170950; 170951; 170952; M0891G)
– Weight of palette +35 conopies 400 kg brutto

– 165x96x230 cm for connopy 160x90 cm (170955; 170956; 170957; M0921G)
– Weight of palette +35 conopies 520 kg brutto

Complete set for self assembly.



PLUTVORDACH

Füllung – Acrykglass 4 mm.

klar

Konstruktion: Aluminium pulverbeschichtet

Gewicht – 11 kg für Vordäch 120x90 cm
– 41 kg für Vordäch 160x90 cm

Abmessungen der Verpackung – 123x94x6 cm für Vordäch 120x90 cm
– 163x94x6 cm für Vordäch 160x90 cm

Paletteneinheit 35 Stück

Abmessungen der Palette – 115x96x230 cm für Vordäch 120x90 cm (170950; 170951; 170952; M0891G)
Gewicht der Palette 400 kg brutto

– 165x96x230 cm für Vordäch 160x90 cm 170955; 170956; 170957; M0921G)
Gewicht der Palette 520 kg brutto

Komplett mit Schrauben und Dübel zur Selbstmontage.



AUVENT PLONGEANT AVEC LE PLAQUE ACRYLIQUE

Réalisation des auvents – plaque acrylique claire 4mm.

clair

Construction des auvents: Aluminium paint en pulverisation

Poids - 11 kg/pièce pour un auvent 120x90 cm
- 14 kg/pièce pour un auvent 160x90 cm

Dimensions du colis - 123x94x6 cm pour un auvent 120x90 cm
- 163x94x6 cm pour un auvent 160x90 cm

Palletisation - 35 pièce / palette

Dimension de la palette:





- 115x96x230 cm pour un auvent 120x90cm cm (170950; 170951; 170952; M0891G)
- Poids de la palette + 35 auvents 400 kg brut

- 165x96x230 cm pour un auvent 160x90 cm (170955; 170956; 170957; M0921G)
- Poids de la palette + 35 auvents 520 kg brut

Inclus les vis et les chevilles pour le montage individuel.

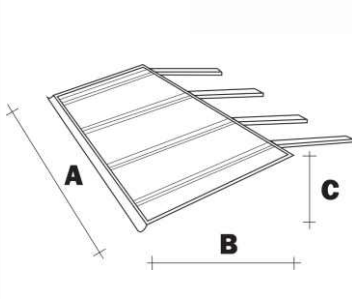
DASZEK BALKONOWY PŁASKI

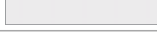
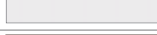

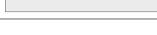
|  | Wymiary | | | Wypełnienie | Kolor profili | Indeks | Lp. |
|--|---------|--------|--------|--|---------------|--------|-----|
| | A (cm) | B (cm) | C (cm) | | | | |
| | 100 | 60 | 17 |  | RAL9016 | M0770 | 223 |
| | 100 | 60 | 17 |  | RAL8017 | M0772 | 224 |
| | 100 | 60 | 17 |  | RAL7024 | M0770G | 225 |
| | 200 | 60 | 17 |  | RAL9016 | M0774 | 226 |
| | 200 | 60 | 17 |  | RAL8017 | M0776 | 227 |
| | 200 | 60 | 17 |  | RAL7024 | M0774G | 228 |

Opcjonalnie dostępne elementy łączące kilka daszków z systemu balkonowego:

| Kolor profili | Indeks | Lp. |
|---------------|--------|-----|
| RAL9016 | M0778 | 229 |
| RAL8017 | M0780 | 230 |
| RAL7024 | M0778G | 231 |

 **Wypełnienie daszków:** poliwęglan komorowy 4,5mm.

przejrzysty

brązowe

Konstrukcja daszków: aluminium lakierowane proszkowo RAL8017 lub RAL9016 lub RAL7024

Waga daszków:

- 4kg dla daszka 100x60 cm
- 7kg dla daszka 200x60 cm

Wymiar opakowania:

- 102x62x6cm dla daszka 204x75 cm
- 204x62x6cm dla daszka 158x90 cm

Paletowanie:

- 35 sztuk/paleta

Wymiar palety:

- 104x64x230 cm dla daszka 100x60 cm (M0770; M0772; M0770G)
- Waga palety+35 daszków 165kg brutto
- 206x64x230 cm dla daszka 200x60 cm (M0774; M0776; M0774G)
- Waga palety+35 daszków 270kg brutto

W komplecie śruby i kołki rozporowe do samodzielnego montażu daszka.



FLAT CONNOY FOR BALCONY

Multiwall polycarbonate plate 4,5 mm.

transparent

brown

Construction of conopies:

Aluminium powder coated RAL8017 or RAL9016 or RAL7024

Optionally available combining elements of several connoy of the system of the balcony.

Weight of conopies – 4 kg / pcs for connoy 100x60 cm; 7 kg / pcs. for connoy 200x60 cm

Size of packaging – 102x62x6 cm for connoy 204x75 cm
– 204x62x6 cm for connoy 158x90 cm

Palletizing – 35 pcs./palette

Size of palette – 104x64x230 cm for connoy 100x60 cm (M0770; M0772; M0770G)
– Weight of palette +35 conopies 165 kg brutto

– 206x64x230 cm for connoy 200x60 cm (M0774; M0776; M0774G)
– Weight of palette +35 conopies 270 kg brutto

Complete set for self assembly



FLAHESBALKONVORDACH

Füllung – Polykarbonat Kammerplate 4,5 mm

klar

braun

Konstruktion: Aluminium pulverbeschichtet RAL8017 oder RAL9016 oder RAL7024

Als zusätzliche Option, die Verbindung Elemente für Balkonvordach System.

Gewicht 4 kg für Vordäch 100x60 cm; 7 kg für Vordäch 200x60 cm

Abmessungen der Verpackung – 102x62x6 cm für Vordäch 204x75 cm
– 204x62x6 cm für Vordäch 158x90 cm

Paletteneinheit 35 Stück

Abmessungen der Palette:

– 104x64x230 cm für Vordäch 100x60 cm (M0770; M0772; M0770G)
– Gewicht der Palette 165 kg brutto

– 206x64x230 cm für Vordäch 200x60 cm (M0774; M0776; M0774G)
– Gewicht der Palette 270 kg brutto

Komplett mit Schrauben und Dübel zur Selbstmontage.



MARQUISIE DROITE POUR LE BALCON

Réalisation des auvents – polycarbonat alvéolaire 4,5mm

clair

fumé

Construction des auvents:

Aluminium paint en pulverisation

Poids - 10 kg/pièce

Dimensions du colis - 163x94x6 cm

Palletisation - 35 pièce / palette

Dimension de la palette:



– 104x64x230 cm pour un auvent 100x90 cm (M0770; M0772; M0770G)
– Poids de la palette + 35 auvents 165 kg brut

– 206x64x230 cm pour un auvent 200x90cm (M0774; M0776; M0774G)
– Poids de la palette + 35 auvents 270 kg brut

Inclus les vis et les chevilles pour le montage individuel.

DASZEK JEDNOSTRONNIE ŁUKOWY

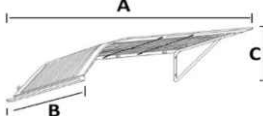

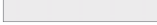
|  | Wymiary | | | Wypełnienie | Kolor profili | Indeks | Lp. |
|--|---------|--------|--------|---|----------------|--------|-----|
| | A (cm) | B (cm) | C (cm) | | | | |
| | 160 | 75 | 75 |  | Biały RAL9016 | M0308 | 232 |
| | 160 | 75 | 75 |  | Brąz RAL8017 | M0309 | 233 |
| | 160 | 75 | 75 |  | Grafit RAL7024 | M0308G | 234 |

 **Wypełnienie daszków** – płyta poliwęglan komorowy 4,5 mm.

 przejrzysty

 brązowe

Konstrukcja daszków:

Aluminium lakierowane proszkowo RAL8017 lub RAL9016 lub RAL7024

Waga daszków - 9 kg dla daszka 160x75 cm

Wymiar opakowania – 177x70x6 cm dla daszka 160x75 cm

Paletowanie – 30 sztuk/paleta

Wymiar palety – 176x72x200 cm

– Waga palety+30 daszków 290 kg brutto

W komplecie śruby i kołki rozporowe do samodzielnego montażu daszka.



ONE SIDED ARCHED CONNOPY

Multiwall polycarbonate plate 4,5 mm.

transparent

brown

Construction of conopies:

Aluminium powder coated RAL 8017 or RAL9016 or RAL7024

Weight of conopies – 9 kg for conopy 160x75 cm

Size of packaging – 177x70x6 cm for conopy 160x75 cm

Palletizing – 30 pcs./palette

Size of palette – 179x72x200 cm for conopy 160x75 cm

– Weight of palette +30 conopies 290 kg brutto

Complete set for self assembly



EINSEITIG GEBOGENE VORDACH

Füllung – Polykarbonat Kammerplate 4,5 mm.

klar

braun

Konstruktion:

Aluminium pulverbeschichtet RAL8017 oder RAL9016 oder RAL7024

Gewicht 9 kg für Vordäch 160x75 cm

Abmessungen der Verpackung – 177x70x6 cm für Vordäch160x75 cm

Paletteneinheit 30 Stück

Abmessungen der Palette – 179x72x200 cm für Vordäch 160x75 cm

Gewicht der Palette 290 kg brutto

Komplett mit Schrauben und Dübel zur Selbstmontage.



MARQUISE

Réalisation des auvents – polycarbonat alvéolaire 4,5 mm

clair

fumé

Construction des auvents:

Aluminium paint en pulverisation

Poids - 9 kg/pièce

Dimensions du colis - 177x70x6 cm

Palletisation - 30 pièce / palette

Dimension de la palette:







- 177x70x200 cm

- Poids de la palette + 30 auvents 290 kg brut

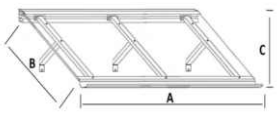
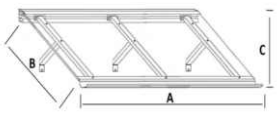
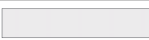
Inclus les vis et les chevilles pour le montage individuel.

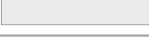
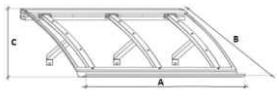
DASZEK PŁASKI PLUS & DASZEK ARCO PLUS



|  | Wymiary | | | Wypełnienie | Kolor profili | | Indeks | Lp. |
|---|---------|--------|--------|---|---------------|---------|--------|-----|
| | A (cm) | B (cm) | C (cm) | | | | | |
|  | 210 | 105 | 35 |  | Biały | RAL9016 | M1140 | 235 |
| | 210 | 105 | 35 |  | Brąz | RAL8017 | M1141 | 236 |
| | 210 | 105 | 35 |  | Grafit | RAL7024 | M1140G | 237 |
|  | 210 | 105 | 35 |  | Biały | RAL9016 | M1130 | 238 |
| | 210 | 105 | 35 |  | Brąz | RAL8017 | M1131 | 239 |
| | 210 | 105 | 35 |  | Grafit | RAL7024 | M1130G | 240 |

 **Wypełnienie daszków** – płyta poliwęglan komorowy 8 mm.

 przejrzysty

 brązowe

Konstrukcja daszków:

Aluminium lakierowane proszkowo RAL8017 lub RAL9016 lub RAL7024

Waga daszków - 12 kg dla daszka 210x105 cm

Wymiar opakowania – 215x102x13 cm dla daszka 210x105 cm

Paletowanie – 15 sztuk/paleta

Wymiar palety – 217x104x230 cm dla daszka 210x105 cm

– Waga palety+15 daszków 215 kg brutto

W komplecie śruby i kołki rozporowe do samodzielnego montażu daszka.



FLAT CONNOPY PLUS & CONNOPY ARCO PLUS

Multiwall polycarbonate plate 8 mm.

transparent

brown

Construction of conopies:

Aluminium powder coated RAL 8017 or RAL9016 or RAL7024

Weight of conopies – 12 kg for connopy 210x105 cm

Size of packaging – 215x102x13 cm for connopy 210x105 cm

Palletizing – 15 pcs./palette

Size of palette – 217x104x230 cm for connopy 210x105 cm

– Weight of palette +15 conopies 215 kg brutto

Complete set for self assembly



PLUTVORDACH PLUS & VORDACH ARCO PLUS

Füllung – Polykarbonat Kammerplate 8 mm.

klar

braun

Konstruktion:

Aluminium pulverbeschichtet RAL8017 oder RAL9016 oder RAL7024

Gewicht 12 kg für Vordäch 210x105 cm

Abmessungen der Verpackung – 215x102x13 cm für Vordäch 210x105 cm

Paletteneinheit 15 Stück

Abmessungen der Palette – 217x104x230 cm für Vordäch 210x105 cm

Gewicht der Palette 215 kg brutto

Komplett mit Schrauben und Dübel zur Selbstmontage.



MARQUISE DROITE PLUS & MARQUISE ARCO PLUS

Réalisation des auvents – polycarbonat alvéolaire 8 mm

clair

fumé

Construction des auvents:

Aluminium paint en pulverisation

Poids - 12 kg/pièce

Dimensions du colis - 215x102x13 cm

Palletisation - 15 pièce / palette

Dimension de la palette:



- 217x104x230 cm

- Poids de la palette + 15 auvents 215 kg brut

Inclus les vis et les chevilles pour le montage individuel.

DASZEK ARCO

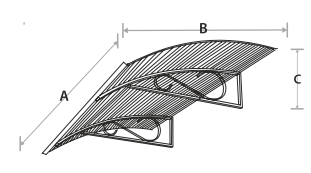

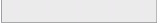
|  | Wymiary | | | Wypełnienie | Kolor profili | Indeks | Lp. |
|--|---------|--------|--------|---|----------------|--------|-----|
| | A (cm) | B (cm) | C (cm) | | | | |
| | 150 | 90 | 25 |  | Biały RAL9016 | M0843 | 241 |
| | 150 | 90 | 25 |  | Brąz RAL8017 | M0853 | 242 |
| | 150 | 90 | 25 |  | Grafit RAL7024 | M0853G | 243 |

 **Wypełnienie daszków** – płyta poliwęglan komorowy 4,5 mm.

 przejrzysty

 brązowe

Konstrukcja daszków:

Aluminium lakierowane proszkowo

Waga daszków - 7 kg / sztuka

Wymiar opakowania – 153x94x6 cm

Paletowanie – 35 sztuk/paleta

Wymiar palety – 155x96x230 cm

– Waga palety+35 daszków 265 kg brutto

W komplecie śruby i kołki rozporowe do samodzielnego montażu daszka.



CONNOPY ARCO

Multiwall polycarbonate plate 4,5 mm.

transparent

brown

Construction of conopies:

Aluminium powder coated

Weight of conopies – 7 kg / pcs.

Size of packaging – 153x94x6 cm

Palletizing – 35 pcs./palette

Size of palette – 155x96x230 cm

– Weight of palette +35 conopies 265 kg brutto

Complete set for self assembly.



RUNDBOGENVORDACH ARCO

Füllung – Polykarbonat Kammerplate 4,5 mm.

klar

braun

Konstruktion:

Aluminium pulverbeschichtet

Gewicht 7 kg

Abmessungen der Verpackung – 153x94x6 cm

Paletteneinheit 35 Stück

Abmessungen der Palette – 155x96x230 cm

Gewicht der Palette 265 kg brutto

Komplett mit Schrauben und Dübel zur Selbstmontage.



ARCO POLICARBONAT ALVÉOLAIRE

Réalisation des auvents – polycarbonat alvéolaire 4,5mm

clair

fumé

Construction des auvents:

Aluminium paint en pulverisation

Poids - 7 kg/pièce

Dimensions du colis - 153x94x6 cm

Palletisation - 35 pièce / palette

Dimension de la palette:

- 155x96x230 cm

- Poids de la palette + 35 auvents 265 kg brut

Inclus les vis et les chevilles pour le montage individuel.

DASZEK ARCO RETRO



| 160x90 | Wymiary | | | Wypełnienie | Kolor profili | Indeks | Lp. |
|--------|---------|--------|--------|-------------|----------------|--------|-----|
| | A (cm) | B (cm) | C (cm) | | | | |
| | 160 | 90 | 25 | | Biały RAL9016 | M1090 | 244 |
| | 160 | 90 | 25 | | Czarny RAL9005 | M1100 | 245 |
| | 200 | 90 | 25 | | Biały RAL9016 | M1110 | 246 |
| | 200 | 90 | 25 | | Czarny RAL9005 | M1120 | 247 |

 **Wypełnienie daszków** – płyta poliwęglan komorowy 4,5 mm.

 przejrzysty

 brązowe

Konstrukcja daszków:

Aluminium lakierowane proszkowo

Waga daszków – 9 kg / sztuka dla daszka 160x90 cm
– 12 kg / sztuka dla daszka 200x90 cm

Wymiar opakowania – 163x94x6 cm dla daszka 160x90 cm
– 203x94x6 cm dla daszka 200x90 cm

Paletowanie – 35 sztuk/paleta

Wymiar palety – 165x96x230 cm (M1090; M1100)

– Waga palety+35 daszków 335 kg brutto

– 205x96x230 cm (M1110; M1120)

– Waga palety+35 daszków 445 kg brutto

W komplecie śruby i kołki rozporowe do samodzielnego montażu daszka.



CONNOPY ARCO RETRO

Multiwall polycarbonate plate 4,5 mm.

transparent

brown

Construction of conopies:

Aluminium powder coated

Weight of conopies – 9 kg / pcs. for conopy 160x90 cm
– 12 kg / pcs. for conopy 200x90 cm

Size of packaging – 163x94x6 cm for conopy 160x90 cm
– 203x94x6 cm for conopy 200x90 cm

Palletizing – 35 pcs./palette

Size of palette – 165x96x230 cm (M1090; M1100)
– Weight of palette +35 conopies 335 kg brutto

– 205x96x230 cm (M1110; M1120)
– Weight of palette +35 conopies 45 kg brutto

Complete set for self assembly.



RUNDBOGENVORDACH ARCO RETRO

Füllung – Polykarbonat Kammerplatte 4,5 mm.

klar

braun

Konstruktion:

Aluminium pulverbeschichtet

Gewicht – 9 kg für Vordäch 160x90 cm
– 12 kg für Vordäch 200x90 cm

Abmessungen der Verpackung – 163x94x6 cm für Vordäch 160x90 cm
– 203x94x6 cm für Vordäch 200x90 cm

Paletteneinheit 35 Stück

Abmessungen der Palette – 165x96x230 cm (M1090; M1100921G)
Gewicht der Palette 335 kg brutto

– 205x96x230 cm (M1110; M1120)
Gewicht der Palette 545 kg brutto

Komplett mit Schrauben und Dübel zur Selbstmontage.



ARCO RETRO POLICARBONAT ALVÉOLAIRE

Réalisation des auvents – polycarbonat alvéolaire 4,5mm

clair

fumé

Construction des auvents:

Aluminium paint en pulverisation

Poids - 9 kg/pièce pour un auvent 160x90 cm
- 12 kg/pièce pour un auvent 200x90 cm

Dimensions du colis - 163x94x6 cm pour un auvent 160x90 cm
- 203x94x6 cm pour un auvent 200x90 cm

Palletisation - 35 pièce / palette

Dimension de la palette:



- 165x96x230 cm (M1090; M1100)
- Poids de la palette + 35 auvents 335 kg brut

- 205x96x230 cm (M1110; M1120)
- Poids de la palette + 35 auvents 445 kg brut

Inclus les vis et les chevilles pour le montage individuel.

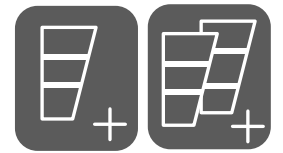
DASZEK ŁUKOWY RETRO

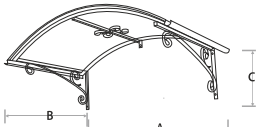
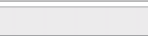

|  | Wymiary | | | Wypełnienie | Kolor profili | | Indeks | Lp. |
|---|---------|--------|--------|--|---------------|---------|--------|-----|
| | A (cm) | B (cm) | C (cm) | | | | | |
| | 158 | 90 | 40 |  | Biały | RAL9016 | M1070 | 248 |
| | 158 | 90 | 40 |  | Czarny | RAL9005 | M1080 | 249 |

 **Wypełnienie daszków** – płyta poliwęglan komorowy 4,5 mm.

przejrzysty

brązowe

Konstrukcja daszków:

Aluminium lakierowane proszkowo

Waga daszków - 10 kg

Wymiar opakowania – 163x94x6 cm

Paletowanie – 35 sztuk/paleta

Wymiar palety – 165x96x230 cm

– Waga palety+35 daszków 375 kg brutto

W komplecie śruby i kołki rozporowe do samodzielnego montażu daszka.



ARCHED SHED ROOF RETRO

Multiwall polycarbonate plate 4,5 mm.

transparent

brown

Construction of conopies:

Aluminium powder coated

Weight of conopies – 10 kg / pcs.

Size of packaging – 163x94x6 cm

Palletizing – 35 pcs./palette

Size of palette – 165x96x230 cm

– Weight of palette +35 conopies 375 kg brutto

Complete set for self assembly.



RUNDBOGENVORDACH RETRO

Füllung – Polykarbonat Kammerplate 4,5 mm.

klar

braun

Konstruktion:

Aluminium pulverbeschichtet

Gewicht 10 kg

Abmessungen der Verpackung – 163x94x6 cm

Paletteneinheit 35 Stück

Abmessungen der Palette – 165x96x230 cm

Gewicht der Palette 375 kg brutto

Komplett mit Schrauben und Dübel zur Selbstmontage.



AUVENT VOÛTÉ POLICARBONAT ALVÉOLAIRE

Réalisation des auvents – polycarbonat alvéolaire 4,5mm

clair

fumé

Construction des auvents:

Aluminium paint en pulverisation

Poids - 10 kg/pièce

Dimensions du colis - 163x94x6 cm

Palletisation - 35 pièce / palette

Dimension de la palette:

- 165x96x230 cm

- Poids de la palette + 35 auvents 375 kg brut

Inclus les vis et les chevilles pour le montage individuel.

ŚCIANKA DO DASZKA ŁUKOWEGO RETRO

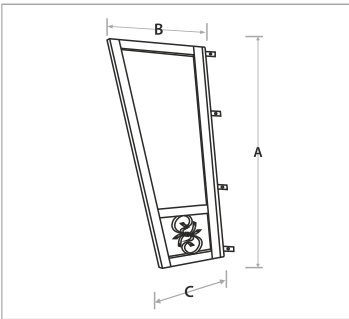

| Wymiary | | | Wypełnienie | Kolor profili | | Indeks | Lp. |
|---------|--------|--------|---|---------------|---------|--------|-----|
| A (cm) | B (cm) | C (cm) | | | | | |
| 180 | 53 | 30 |  | Biały | RAL9016 | M1220 | 250 |
| 180 | 53 | 30 |  | Czarny | RAL9005 | M1230 | 251 |

 **Wypełnienie ścianek** – płyta poliwęglan komorowy 4,5 mm.

przejrzysty

brązowe

Konstrukcja ścianek:

Aluminium lakierowane proszkowo

Waga ścianek - 10 kg

Wymiar opakowania – 184x55x3 cm

Paletowanie – 50 sztuk/paleta

Wymiar palety – 186x57x170 cm

– Waga palety+50 ścianek 525 kg brutto

W komplecie śruby i kołki rozporowe do samodzielnego montażu daszka.



SIDE PANEL FOR ARCHED SHED ROOF RETRO

Multiwall polycarbonate plate 4,5 mm.

transparent

brown

Construction of side panel:

Aluminium powder coated

Weight of side panel – 10 kg / pcs.

Size of packaging – 184x55x3 cm

Palletizing – 50 pcs./palette

Size of palette – 186x57x170 cm

– Weight of palette +50 connopies 525 kg brutto

Complete set for self assembly.



SEITENTEIL RETRO

Füllung – Polykarbonat Kammerplate 4,5 mm.

klar

braun

Konstruktion:

Aluminium pulverbeschichtet

Gewicht 10 kg

Abmessungen der Verpackung – 184x55x3 cm

Paletteneinheit 50 Stück

Abmessungen der Palette – 186x57x170 cm

Gewicht der Palette 525 kg brutto

Komplett mit Schrauben und Dübel zur Selbstmontage.



PAROI POUR AUVENT VOÛTÉ DU POLICARBONAT ALVÉOLAIRE

Réalisation des auvents – polycarbonat alvéolaire 4,5mm

clair

fumé

Construction des auvents:

Aluminium paint en pulverisation

Poids - 10 kg/pièce

Dimensions du colis - 184x55x3 cm

Palletisation - 50 pièce / palette

Dimension de la palette:



- 186x57x170 cm

- Poids de la palette + 50 auvents 525 kg brut

Inclus les vis et les chevilles pour le montage individuel.

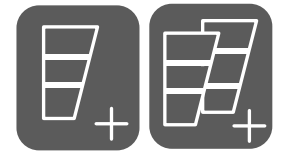
DASZEK PŁASKI RETRO

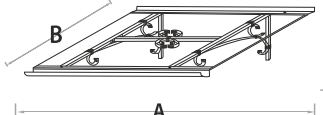
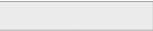

|  | Wymiary | | | Wypełnienie | Kolor profili | | Indeks | Lp. |
|---|---------|--------|--------|--|---------------|---------|--------|-----|
| | A (cm) | B (cm) | C (cm) | | | | | |
| | 160 | 90 | 40 |  | Biały | RAL9016 | M1050 | 252 |
| | 160 | 90 | 40 |  | Czarny | RAL9005 | M1060 | 253 |

 **Wypełnienie daszków** – płyta poliwęglan komorowy 4,5 mm.

 przejrzysty

 brązowe

Konstrukcja daszków:

Aluminium lakierowane proszkowo

Waga daszków - 9 kg

Wymiar opakowania – 163x94x6 cm

Paletowanie – 35 sztuk/paleta

Wymiar palety – 165x96x230 cm

– Waga palety+35 daszków 335 kg brutto

W komplecie śruby i kołki rozporowe do samodzielnego montażu daszka.



FLAT CONNOPY RETRO

Multiwall polycarbonate plate 4,5 mm.

transparent

brown

Construction of conopies:

Aluminium powder coated

Weight of conopies – 9 kg / pcs.

Size of packaging – 163x94x6 cm

Palletizing – 35 pcs./palette

Size of palette – 165x96x230 cm
– Weight of palette +35 conopies 335 kg brutto

Complete set for self assembly.



PLUVORDACH RETRO

Füllung – Polykarbonat Kammerplate 4,5 mm.

klar

braun

Konstruktion:

Aluminium pulverbeschichtet

Gewicht 9 kg

Abmessungen der Verpackung – 163x94x6 cm

Paletteneinheit 35 Stück

Abmessungen der Palette – 165x96x230 cm
Gewicht der Palette 335 kg brutto

Komplett mit Schrauben und Dübel zur Selbstmontage.



AUVENT PLONGEANT POLICARBONAT ALVÉOLAIRE

Réalisation des auvents – polycarbonat alvéolaire 4,5mm

clair

fumé

Construction des auvents:

Aluminium paint en pulverisation

Poids - 9 kg/pièce

Dimensions du colis - 163x94x6 cm

Palletisation - 35 pièce / palette

Dimension de la palette:

- 165x96x230 cm
- Poids de la palette + 35 auvents 335 kg brut

Inclus les vis et les chevilles pour le montage individuel.

ŚCIANKA DO DASZKA PŁASKIEGO RETRO

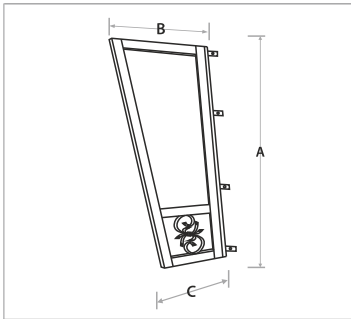

| Wymiary | | | Wypełnienie | Kolor profili | | Indeks | Lp. |
|---------|--------|--------|-------------|---------------|---------|--------|-----|
| A (cm) | B (cm) | C (cm) | | | | | |
| 180 | 53 | 30 | | Biały | RAL9016 | M1240 | 254 |
| 180 | 53 | 30 | | Czarny | RAL9005 | M1250 | 255 |

Wypełnienie ścianek – płyta poliwęglan komorowy 4,5 mm.

przejrzysty

brązowe

Konstrukcja ścianek:

Aluminium lakierowane proszkowo

Waga ścianek - 10 kg

Wymiar opakowania – 184x55x3 cm

Paletowanie – 50 sztuk/paleta

Wymiar palety – 186x57x170 cm

– Waga palety+50 ścianek 525 kg brutto

W komplecie śruby i kołki rozporowe do samodzielnego montażu daszka.



SIDE PANEL FOR ARCHED SHED ROOF RETRO

Multiwall polycarbonate plate 4,5 mm.

transparent

brown

Construction of side panel:

Aluminium powder coated

Weight of side panel – 10 kg / pcs.

Size of packaging – 184x55x3 cm

Palletizing – 50 pcs./palette

Size of palette – 186x57x170 cm
– Weight of palette +50 side panels 525 kg brutto

Complete set for self assembly.



SEITENTEIL RETRO

Füllung – Polykarbonat Kammerplatte 4,5 mm.

klar

braun

Konstruktion:

Aluminium pulverbeschichtet

Gewicht 10 kg

Abmessungen der Verpackung – 184x55x3 cm

Paletteneinheit 50 Stück

Abmessungen der Palette – 186x57x170 cm
Gewicht der Palette 525 kg brutto

Komplett mit Schrauben und Dübel zur Selbstmontage.



PAROIS POUR UN AUVENT PLONGEANT

Réalisation des auvents – polycarbonat alvéolaire 4,5mm

clair

fumé

Construction des auvents:

Aluminium paint en pulverisation

Poids - 10 kg/pièce

Dimensions du colis - 184x55x3 cm

Palletisation - 50 pièce / palette

Dimension de la palette:

- 186x57x170 cm
- Poids de la palette + 50 auvents 525 kg brut

Inclus les vis et les chevilles pour le montage individuel.

WIATA ROWEROWA MR02 - LASTRA



| Ikona | Nazwa produktu | Wymiary (AxBxC) | Specyfikacja | Lp. | |
|-------|--------------------------------------|------------------|--|---|-----|
| | MODEL MR02 - "L" | 5000x3000x2100mm | Profil konstrukcyjny 50x50x2; Łączniki ze stali 5mm; 256 Śruby łączeniowe wytrzymałościowe | | |
| | MODEL MR02 - "XL" | 6000x4000x2100mm | Profil konstrukcyjny 50x50x2; Łączniki ze stali 5mm; 257 Śruby łączeniowe wytrzymałościowe | | |
| | ŚCIANKA BOCZNA Z PCB | „L” krótka | 2800x1500 mm | Konstrukcja Aluminiowa z wypełnieniem z poliwęglanu komorowego. | 258 |
| | | „L” długa | 3300x1500 mm | | 259 |
| | | „XL” krótka | 3800x1500 mm | Konstrukcja w stanie surowym. | 260 |
| | | „XL” długa | 4300x1500 mm | | 261 |
| | ŚCIANKA BOCZNA ZE STALI PERFOROWANEJ | „L” krótka | 2800x1500 mm | Blacha stalowa perforowana 1,5mm | |
| | | „L” długa | 3300x1500 mm | | |
| | | „XL” krótka | 3800x1500 mm | | |
| | | „XL” długa | 4300x1500 mm | | |

STOJAKI ROWEROWE

| Ikona | Nazwa produktu | Wymiary (AxBxC) | Specyfikacja | Lp. |
|-------|----------------|-----------------|---|-----|
| | MODEL S1 | 1000x340 mm | Rura stalowa fi25mm przęgnięta w spirale o podstawie montażowej z profilu 40x20mm. Średnica okręgów spirali około 340mm | 262 |
| | MODEL S2 | 2000x340 mm | | 263 |
| | MODEL L1 | 1000x580x520 mm | Rura stalowa fi16mm przęgnięta w kształt litery L o podstawie montażowej z profilu 40x20mm | 264 |
| | MODEL L2 | 2000x580x520 mm | | 265 |

BICYCLE SHED MR02 - LASTRA



| Icon | Product | Dimensions (AxBxC) | Specification | No. | | |
|------|--------------------------------|--------------------|--|--------------|--|-----|
| | MODEL MR02 - "L" | 5000x3000x2100mm | Construction profile 50x50x2; Steel fasteners 5 mm; Screws connectors strength | 256 | | |
| | MODEL MR02 - "XL" | 6000x4000x2100mm | Construction profile 50x50x2; Steel fasteners 5 mm; Screws connectors strength | 257 | | |
| | SIDE PANEL OF PCB | „L“ | short | 2800x1500 mm | Aluminium construction with fulfillment of multiwall polycarbonate. The construction in the rough. | 258 |
| | | | long | 3300x1500 mm | | 259 |
| | | „XL“ | short | 3800x1500 mm | | 260 |
| | | | long | 4300x1500 mm | | 261 |
| | SIDE PANEL OF PERFORATED STEEL | „L“ | short | 2800x1500 mm | Sheet of perforated steel 1,5mm | |
| | | | long | 3300x1500 mm | | |
| | | „XL“ | short | 3800x1500 mm | | |
| | | | long | 4300x1500 mm | | |

BICYCLE RACKS

| Icon | Product | Dimensions (AxBxC) | Specification | No. |
|------|----------|--------------------|---|-----|
| | MODEL S1 | 1000x340 mm | Steel pipe fi 25 mm cut in spirals on the basis of assembly profile 40x20mm. The diameter of the circles spiral about 340mm | 262 |
| | MODEL S2 | 2000x340 mm | | 263 |
| | MODEL L1 | 1000x580x520 mm | Steel pipe 16 mm cut in the shape of L the mounting base profile 40x20mm | 264 |
| | MODEL L2 | 2000x580x520 mm | | 265 |

ÜBERDACHUNG FÜR FAHRRÄDER MR02 - LASTRA







| Symbol | Produkt | Größe (AxBxC) | Spezifikation | Nr. | |
|--------|---|------------------|---|---|-----|
| | MODELL MR02 - "L" | 5000x3000x2100mm | Profilkonstruktion 50x50x2; 5 mm Stahl-Befestigungen; Schrauben Ausdauer Schalt | 256 | |
| | MODELL MR02 - "XL" | 6000x4000x2100mm | Profilkonstruktion 50x50x2; 5 mm Stahl-Befestigungen; Schrauben Ausdauer Schalt | 257 | |
| | SEITENTEIL AUS POLYKARBONAT KAMMERPLATE | „L“ | kurz 2800x1500 mm | Aluminiumkonstruktion mit Füllung Polycarbonat Kammerplate. Konstruktion im Rohzustand. | 258 |
| | | | lang 3300x1500 mm | | 259 |
| | | „XL“ | kurz 3800x1500 mm | | 260 |
| | | | lang 4300x1500 mm | | 261 |
| | SEITENTEIL AUS PERFORIERTEM STAHL | „L“ | kurz 2800x1500 mm | Gelochtem Stahlblech 1,5mm | |
| | | | lang 3300x1500 mm | | |
| | | „XL“ | kurz 3800x1500 mm | | |
| | | | lang 4300x1500 mm | | |

FAHRRAD STAND

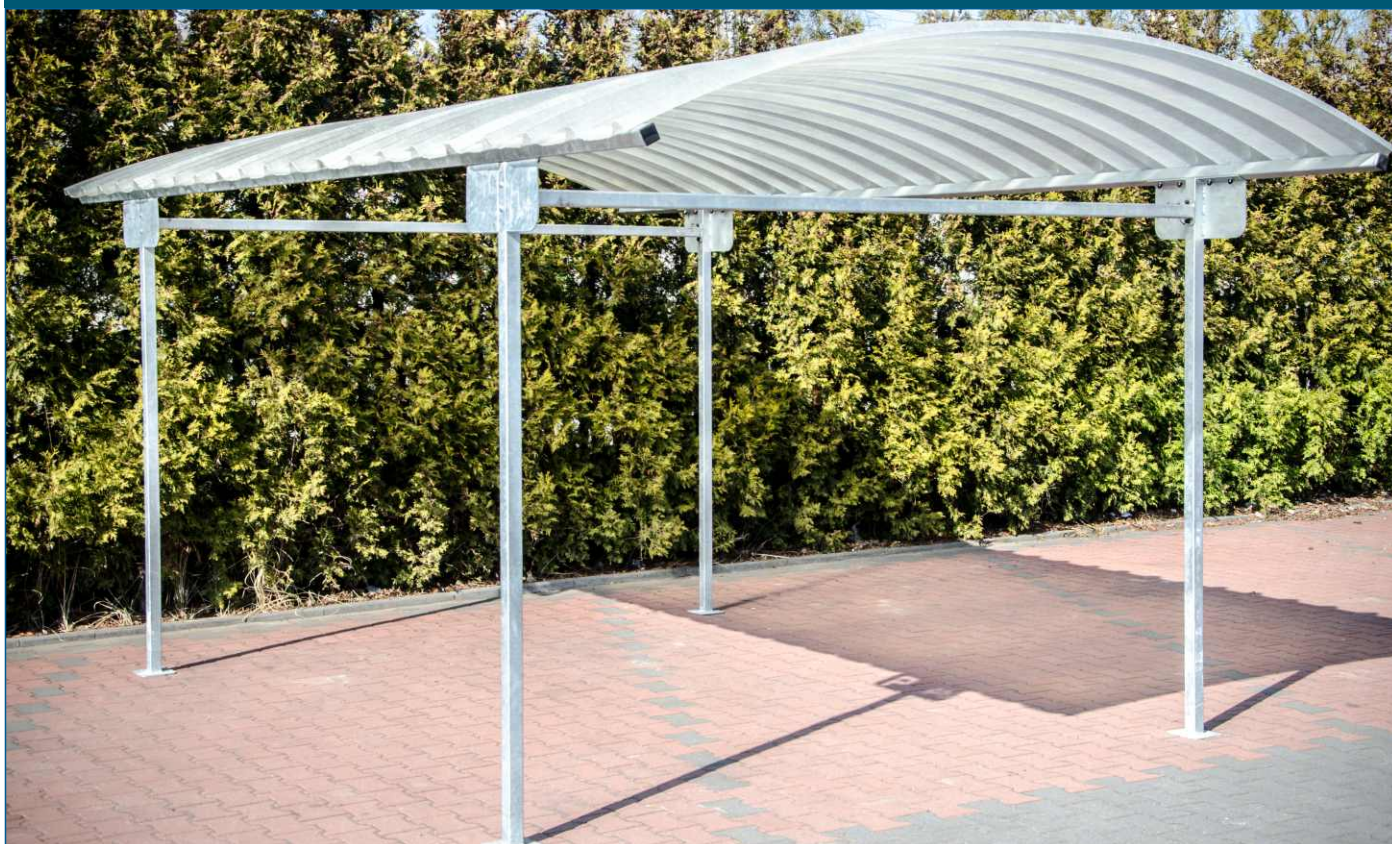
| Symbol | Produkt | Größe (AxBxC) | Spezifikation | Nr. |
|--------|-----------|-----------------|--|-----|
| | MODELL S1 | 1000x340 mm | In spirale gebogen \varnothing 25 mm, auf montagebasis aus montageprofil 40x20 mm der durchmesser von spiralekreise, ungefähr 340 mm | 262 |
| | MODELL S2 | 2000x340 mm | | 263 |
| | MODELL L1 | 1000x580x520 mm | Stahl \varnothing 16 mm gebogen in eine L form, aus montagebasis aus montageprofil 40x20 mm | 264 |
| | MODELL L2 | 2000x580x520 mm | | 265 |

ABRIS POUR LES VÉLOS MR02 - LASTRA

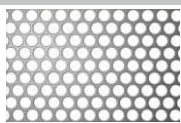

| | NOM | DIMENSIONS (AxBxC) | | SPÉCIFICATION | Lp. | |
|---|--|--------------------|-------|---|--|-----|
|  | Modèle MR02 – "L" | 5000x3000x2100mm | | Profilé de construction 50x50x2, coupleur en acier 5mm, vis d'unionrésistants | 256 | |
|  | Modèle MR02 – "XL" | 6000x4000x2100mm | | Profilé de construction 50x50x2, coupleur en acier 5mm, vis d'unionrésistants | 257 | |
|  | Paroi laterale en polycarbonate alvéolaire | „L" | court | 2800x1500 mm | Construction en aluminium avec une plaque du polycarbonate alvéolaire. Construction en état brut | 258 |
| | | | long | 3300x1500 mm | | 259 |
| | | „XL" | court | 3800x1500 mm | | 261 |
| | | | long | 4300x1500 mm | | 261 |
|  | Paroi laterale en acier perforé | „L" | court | 2800x1500 mm | Tôle perforée 1,5mm | |
| | | | long | 3300x1500 mm | | |
| | | „XL" | court | 3800x1500 mm | | |
| | | | long | 4300x1500 mm | | |

SUPPORTS POUR LES VÉLOS

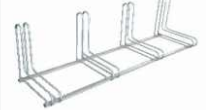
| | NOM | DIMENSIONS (AxBxC) | SPÉCIFICATION | Lp. |
|---|-----------|--------------------|---|-----|
|  | Modèle S1 | 1000x340 mm | Tuyau en acier fi 25mm cambré en spirale de la base du montage 40x20mm. Diamètre du cercle 340mm | 262 |
| | Modèle S2 | 2000x340 mm | | 263 |
|  | Modèle L1 | 1000x580x520 mm | Tuyau en acier fi 16mm cambré en L de la base du montage 40x20mm | 264 |
| | Modèle L2 | 2000x580x520 mm | | 265 |

WIATA ROWEROWA MR01 - ŁUKOWA



| Ikona | Nazwa produktu | Wymiary (AxBxC) | Specyfikacja | Lp. |
|-------|---|-------------------|--|-----|
| | MODEL MR01 - DWA WSPORNIKI | 2100x2650x2350 mm | Profil konstrukcyjny 50x30x2; Łączniki ze stali 5mm; Śruby łączeniowe wytrzymałościowe | 266 |
| | MODEL MR01 A - JEDEN WSPORNIK | 2100x2650x2350 mm | Profil konstrukcyjny 50x30x2; Łączniki ze stali 5mm; Śruby łączeniowe wytrzymałościowe | 267 |
| | ŚCIANKA BOCZNA Z PCB | 2050x1300x1200 mm | Konstrukcja Aluminiowa z wypełnieniem z poliwęglą komorowego. Konstrukcja w stanie surowym. | 268 |
| | ŚCIANKA BOCZNA ZE STALI PERFOROWANEJ | 2050x1200mm | Blacha stalowa perforowana 1,5mm Na indywidualne zamówienie | |



ARCHED BICYCLE SHED MR01



| Icon | Product | Dimensions (AxBxC) | Specification | No. |
|------|---|--------------------|--|-----|
| | MODEL MR01 - TWO SUPPORTS | 2100x2650x2350 mm | Construction profile 50x50x2; Steel fasteners 5 mm; Screws connectors strength | 266 |
| | MODEL MR01 A - ONE SUPPORTS | 2100x2650x2350 mm | Construction profile 50x50x2; Steel fasteners 5 mm; Screws connectors strength | 267 |
| | SIDE PANEL OF PCB | 2050x1300x1200 mm | Aluminium construction with fulfillment of multiwall polycarbonate. The construction in the rough. | 268 |
| | SIDE PANEL OF PERFORATED STEEL | 2050x1200mm | Sheet of perforated steel 1,5mm Individual order | |



ÜBERDACHUNG FÜR FAHRRÄDER MR01 - RUNDBOGEN

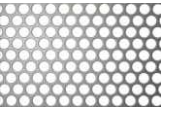

| Symbol | Produkt | Größe (AxBxC) | Spezifikation | Nr |
|---|--|-------------------|---|-----|
|  | MODELL MR01 - ZWEI HALTERUNGEN | 2100x2650x2350 mm | Profilkonstruktion 50x50x2; 5 mm Stahl-Befestigungen; Schrauben Ausdauer Schalt | 266 |
|  | MODELL MR01 A - EIN HALTERUNGEN | 2100x2650x2350 mm | Profilkonstruktion 50x50x2; 5 mm Stahl-Befestigungen; Schrauben Ausdauer Schalt | 267 |
|  | SEITENTEIL AUS POLYKARBONAT KAMMERPLATE | 2050x1300x1200 mm | Aluminiumkonstruktion mit Füllung Polycarbonat Kammerplate. Konstruktion im Rohzustand. | 268 |
|  | SEITENTEIL AUS PERFORIERTEM STAHL | 2050x1200mm | Gelochtem Stahlblech 1,5mm Für Individuelle Beschtelung | |

ABRIS POUR LES VÉLOS MR01 VOÛTÉ

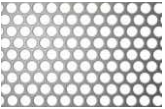

| | NOM | DIMENSIONS (AxBxC) | SPÉCIFICATION | Lp. |
|---|--|--------------------|---|-----|
|  | Modèle MR01 deux supports | 2100x2650x2350 mm | Profilé de construction 50x50x2, coupleur en acier 5mm, vis d'unionrésistants | 266 |
|  | Modèle MR01 A un support | 2100x2650x2350 mm | Profilé de construction 50x50x2, coupleur en acier 5mm, vis d'unionrésistants | 267 |
|  | Paroi lateral en polycarbonat alvéolaire | 2050x1300x1200 mm | Construction en aluminium avec une plaque du polycarbonat alvéolaire. Construction en état brut | 268 |
|  | Paroi lateral en acier perforé | 2050x1200mm | Tôle perforée 1,5mm í commander | |



LAMPION: STOJAK + SZKLANY CYLINDER

| Nazwa produktu | Wymiary (AxBxC) | Specyfikacja | Lp. |
|------------------|--|---|-----|
| STOJAK | 750x230x230 mm | Konstrukcja wykonana została z aluminium, lakierowana proszkowo (kolor według palety RAL) | 269 |
| SZKLANY CYLINDER | 350x200 mm wysokość całkowita - 900 mm szerokość całkowita -230 mm | Szkło bezbarwne | |



LANTERN: RACK + GLASS CYLINDER

| Product | Dimensions (AxBxC) | Specification | No. |
|----------------|--|---|-----|
| RACK | 750x230x230 mm | Construction made of aluminum, coated powder (color according to RAL) | 269 |
| GLASS CYLINDER | 350x200 mm overall height - 900 mm overall width -230 mm | Transparent glass | |



LANTERN: STAND + GLASZYLINDER

| Produkt | Größe (AxBxC) | Spezifikation | Nr. |
|--------------|---|--|-----|
| STAND | 750x230x230 mm | Konstruktion aus pulverbeschichtet Aluminium (Farbe aus Palette RAL) | 269 |
| GLASZYLINDER | 350x200 mm Gesamthöhe - 900 mm Gesamtbreite -230 mm | Klarglas | |



PHOTOPHORE: CONSTRUCTION EN ALUMINIUM + VASE EN VERRE

| NOM | DIMENSIONS (AxBxC) | SPÉCIFICATION | Lp. |
|---------------|--|---|-----|
| CONSTRUCTION | 750x230x230 mm | Construction faite en aluminium, peinte en pulverization (couleur selon la palette RAL) | 269 |
| VASE EN VERRE | 350x200 mm hauteur total 900mm épaisseur total 230mm | Verre sans couleur | |



POPIELNICE

| Nazwa produktu | Wymiary (AxBxC) | Specyfikacja | Lp. |
|----------------|-----------------|--|-----|
| POPIELNICA | 900x80x300 mm | Konstrukcja aluminiowa, malowana proszkowo, podstaw stalowa o grubości 5 mm, średnicy 300 mm, ocynkowana galwanicznie, malowana proszkowo na kolor Alu młotko RAL 9016 | 270 |

ASHTRAY

| Product | Dimensions (AxBxC) | Specification | No. |
|---------|--------------------|---|-----|
| ASHTRAY | 900x80x300 mm | Aluminum construction, powder coated, base steel with a thickness of 5 mm, 300 mm, galvanized, powder coated RAL 9016 | 270 |

ASCHENBECHER

| Produkt | Größe (AxBxC) | Spezifikation | Nr. |
|--------------|---------------|--|-----|
| ASCHENBECHER | 900x80x300 mm | Konstruktion aus pulverbeschichtet Aluminium, Grundlage Stahl mit einer Stärke von 5 mm, 300 mm, galvanisch verzinkt. Farbe RAL 9016 | 270 |

CENDRIERS

| NOM | DIMENSIONS (AxBxC) | SPÉCIFICATION | Lp. |
|----------|--------------------|--|-----|
| CENDRIER | 900x80x300 mm | Construction faite en aluminium, peinture en pulvérisation, diamètre du pied de la base 300 mm, son épaisseur 5mm, galvanisé, peinture en pulvérisation à la couleur martelée alu RAL 9016 | 270 |

